



ENERGY-INTELLIGENT™ HEATING AND COOLING SYSTEMS

08.15

VRV
**PRODUCT
CATALOG**

Setting Daikin's new standards in
indoor comfort and efficiency



Table of contents

Overview	2	Ventilation	106
Why choose Daikin?	3	FXMQ-MFVJU - 100% Outside Air Processing Unit	110
What is Daikin VRV?	4	VAM-GVJU - Energy Recovery Ventilator	112
Why choose Daikin VRV?	5		
Which VRV system offers the best solution?	6	Controls	114
Setting the standards	8	VRV controls matrix	116
Daikin VRV IV	10	VRV control systems	118
Setting the standards, again	10	Individual controllers	120
What does a VRV installation mean to you?	22	BRC1E73 - Navigation Remote Controller	120
Vertical market applications	24	BRC4C82/BRC7E818/BRC7E83/BRC7E830 Wireless Remote Controller	126
	26	BRC2A71 - Simplified Remote Controller	126
Product Portfolio	28	Centralized controllers	128
Outdoor units	30	DCS302C71 - Central Remote Controller	128
Indoor units	32	DCS301C71 - Unified On/Off Controller	129
Accessories	38	DST301BA61 - Schedule Timer	129
	42	Advanced multi-zone controllers	130
Indoor units	44	DCM601A71 - intelligent Touch Manager (iTM)	130
Indoor units overview	48	DCS601C71 - intelligent Touch Controller (iTC)	132
FXMQ-PBVJU - DC-Ducted Concealed Ceiling Unit (Medium Static) and DZK	50	Open protocol interfaces	134
FXDQ-MVJU - Slim-Duct, Built-In Concealed Ceiling Unit	52	Interface for BACnet®, LonWorks® and Modbus	134
FXTQ-PAVJU - Vertical Air Handling Unit	54	VRV monitoring services	135
FXMQ-MVJU - Concealed Ceiling Unit (Medium Static)	56	D-NET Air Conditioning Network Service System	135
FXNQ-MVJU9 - Concealed Floor-Standing Unit	60	Option list	136
FXFQ-TVJU - Round Flow Sensing Cassette	62	Individual zone controllers	136
FXUQ-PVJU - 4-Way Ceiling-Suspended Cassette	64	Centralized controllers	136
FXZQ-MVJU9 - 2'x2' 4-Way Ceiling-Mounted Cassette	66	Advanced multi-zone controllers	136
FXEQ-PVJU - Ceiling-Mounted Cassette	68	Open protocol interface	136
FXHQ-MVJU - Ceiling-Suspended Unit	70	Adapters	137
FXAQ-PVJU - Wall-Mounted Unit	72	WAGO	137
FXLQ-MVJU9 - Floor-Standing Unit	76	Support and Tools	138
	80	Support and tools overview	141
Outdoor units	84	Selection software	142
VRV IV - Air-Cooled Heat Recovery	86	Energy screening and simulation tools	142
VRV IV - Air-Cooled Heat Pump	88	Design and verification	143
VRV III PC - Air-Cooled Heat Recovery	89	Online and tablet reference material	143
VRV IV W-Series - Heat Pump or Heat Recovery	90	Smartphone and mobile reference	144
VRV IV W-Series - Single Module System 208-230V	91	After sales and service	145
VRV IV W-Series - Double Module System 208-230V	92		
VRV IV W-Series - Triple Module System 208-230V	93		
VRV IV W-Series - Single Module System 460V	94		
VRV IV W-Series - Double Module System 460V	96		
VRV IV W-Series - Triple Module System 460V	100		
VRV III-S - Heat Pump 208-230V	102		
VRV IV, VRV III PC, VRV IV W-Series, & VRV III-S - installation space	102		
VRV IV, VRV III PC, VRV IV W-Series, & VRV III-S - piping length	104		
VRV Accessories	104		
Branch Selector boxes	102		
REFNET pipe joints	104		
Hail Guard Kit for VRV IV	105		

OVERVIEW

PRODUCT PORTFOLIO

INDOOR UNITS

OUTDOOR UNITS

VENTILATION

CONTROLS

SUPPORT & TOOLS



Why choose Daikin?

A history of industry-leading product innovation

Becoming a global leader in any industry takes more than just time. For over 90 years Daikin has shown that it takes industry-leading product innovation and a commitment to excellence in order to climb to the top. This commitment led Daikin to develop the first Variable Refrigerant Volume (VRV) system in 1982 and to become a pioneer with our Variable Refrigerant Volume systems.

Daikin's 3 core technologies

Daikin is an industry-leading HVAC technology company. We develop state-of-the-art technology that provides indoor comfort solutions for our customers. We do this by focusing on 3 core technologies. Our refrigerant control technology provides an efficient and effective way to transport heat. Daikin inverter technology allows us to maximize energy efficiency and heat pump technology provides an effective method for moving refrigerant.

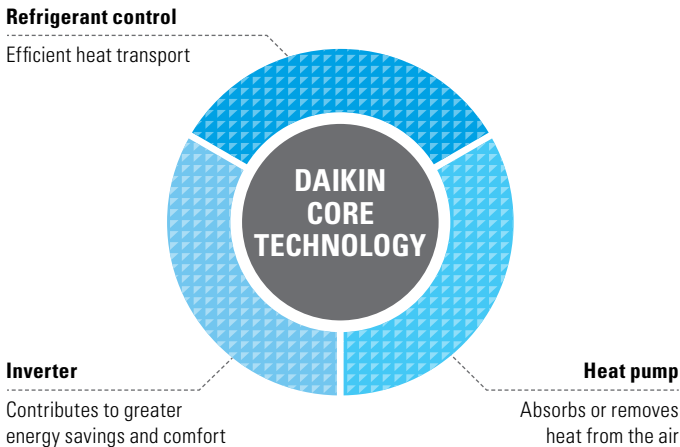

The total solution

Daikin's products and controls are designed to provide a flexible, scalable, total indoor comfort solution. We are committed to supporting our customers at every phase of the project to ensure that the highest quality and most cost effective solution is the one that is provided. From project conception throughout the life of an HVAC system, Daikin provides world class products and support. A single source and total solution for your HVAC requirements.



What is Daikin VRV?

One flexible package

Daikin VRV is a modular, commercially applied air-conditioning and heating system that distributes refrigerant from the outdoor unit to multiple indoor units, providing efficiency, comfortable individual user control and reliability in one flexible package.

Daikin VRV systems provide advanced solutions for almost any large residential to commercial application. Available in air-cooled or water-cooled solutions and heat recovery or heat pump systems, VRV provides advanced heating and cooling options with individual zone control for both open plan and tightly grouped applications.

VRV is built upon 4 basic “Building Blocks” — **Outdoor Unit, Indoor Unit, Piping, and Controls** — providing the attributes of a central chilled water system but with the simplicity of a split system.

This makes it very flexible and ideal for energy-efficient and comfortable cooling and heating of many types of buildings such as banks, health care, skilled care, libraries, storage facilities, conference centers, etc.



Outdoor Unit



Indoor Unit



Piping



Controls

Applications

- Multi-family residences
- Retail
- Hotels
- Office buildings
- Schools, etc.



Inventor and leader in VRV systems since 1982

Unique products that make the difference

■ In efficiency

- Variable Refrigerant Temperature technology leading to excellent energy efficiency
- Indoor units with advanced sensing technology and optional self-cleaning air filter panel

■ In comfort

- Variable Refrigerant Temperature technology preventing cold droughts
- 12 different indoor unit types and 63 models
- Low sound indoor and outdoor units

■ In aesthetics

- Stylish cassettes integrated in the ceiling
- Ceiling suspended cassettes
- Elegant wall mounted units

■ In installation

- Automatic refrigerant charge function
- Self-addressing control system after installation
- VRV Configurator for simplified and time saving commissioning
- Flexible connection possibilities for indoor and outdoor units

■ In control

- intelligent Touch Manager — a mini-BMS/ Centralized Controller that integrates all units in a cost-efficient system
- Easy integrating with third party BMS
- Dedicated control solutions for applications such as offices, shops, hotels, schools, etc.

■ In system design

- User friendly sizing and selection software
- CAD and Revit drawings
- Comprehensive engineering manuals

■ In after market support

- Nationwide field support organization
- 50+ product training facilities in North America
- Dedicated tech support team

■ In reliability

- Refrigerant-cooled electronics in outdoor unit
- Extensive testing before new units leave the factory
- Spare parts available in the US
- ISO 9001 compliant manufacturing
- One of the best warranties* in the industry

* Complete warranty details available from your distributor or at www.daikincomfort.com.



Which VRV system offers the best solution?

Air cooled or water cooled?

Air cooled

- Fast and easy to install — no need for additional components
- Low maintenance costs
- Can be installed both outdoors and indoors
- Up to 38 tons capacity for one system

Components:



Outdoor unit



Indoor unit

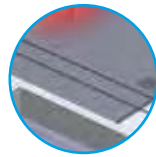

Refrigerant piping

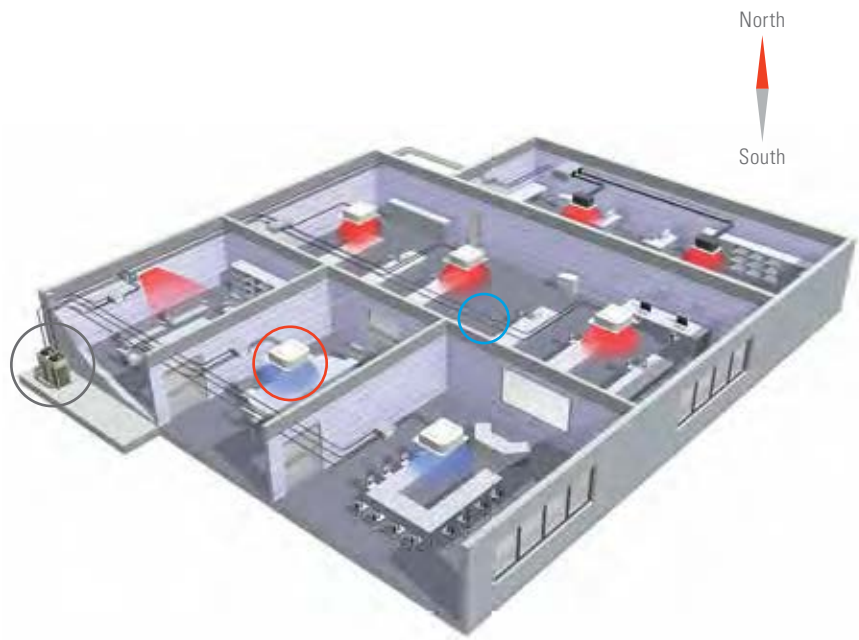

Water cooled

- Suitable for multi-story and large buildings because of the almost unlimited possibilities of water piping
- Not affected by outdoor temperature/ climate conditions
- Reduce CO₂ emissions thanks to the possibility of geothermal energy as a renewable energy source

Components:



Condensing unit

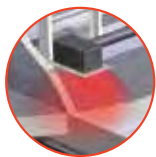

Indoor unit



Refrigerant piping



(Geothermal)
water loop



Heat Recovery or Heat Pump?

VRV Heat Recovery

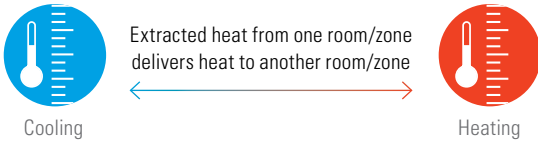

- Simultaneous heating AND cooling from one system
- Efficient heating production by transferring heat from areas requiring cooling
- Maximum individual comfort in all areas
- Heating operation down to -13°F as standard.

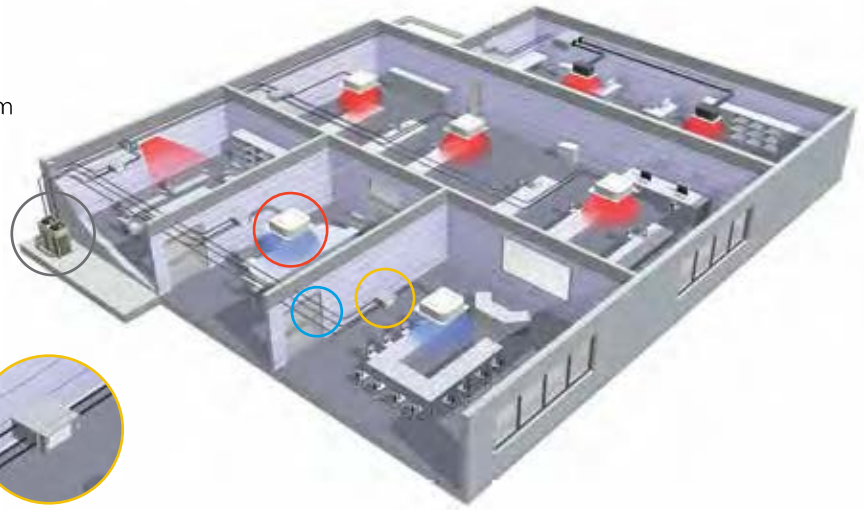

Components:



Outdoor unit



Indoor unit

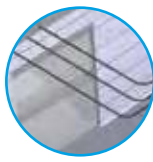

3-pipe refrigerant piping



Single and multi Branch Selector boxes: allows the individual switching of indoor units between heating and cooling

VRV Heat Pump

- For either heating OR cooling operation from one system

Components:



Outdoor unit



Indoor unit



2-pipe refrigerant piping

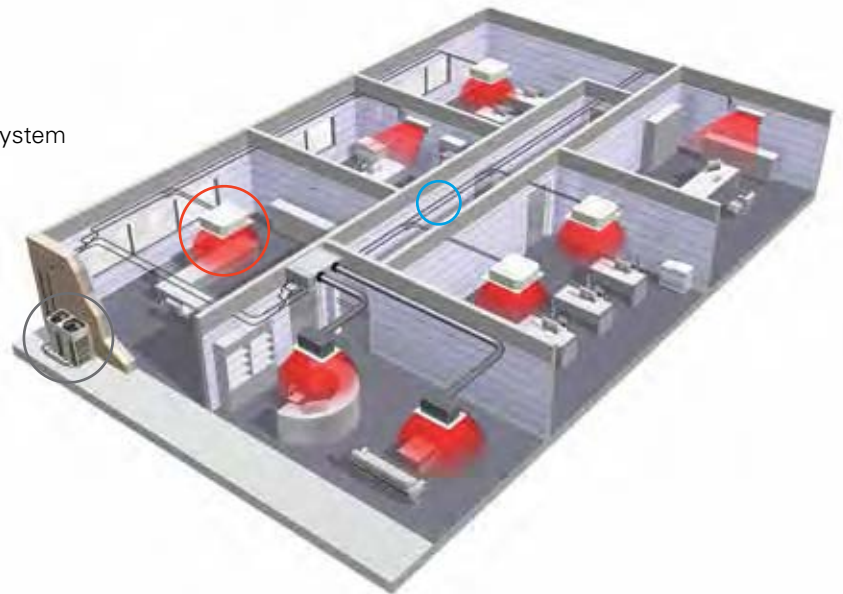

Setting the standards

Over 30 years of VRV history

Daikin invented the first VRV system in 1982 and has continued to set standards in the industry and heighten market expectations. Many of the current market expectations are:

- Energy efficient inverter compressor
- Modular system concept
- Heat recovery function
- Allow long piping lengths
- Heating operation down to -13°F ambient air temperature as standard
- Continuous heat during defrost
- Auto charge at start up

VRV was invented in 1982 as a result of the oil crisis around the world in the 70's. Energy efficiency laws were passed by the Japanese government. The Japanese government and Daikin worked closely together — they looked at a chiller system; pumps, and air handlers as well and how the pump circulates water and how it uses a lot of power. So, they came up with a concept to use refrigerant instead of water to circulate as a heat transfer medium. The first VRV heat recovery system was launched in 1991 implementing the landmark concept of a heat pump chiller that circulates refrigerant instead of water.



Our quality control is based on the idea that the added value we give to products is quality, and that this quality is what customers are buying. And each Daikin employee constantly puts quality ahead of everything else.

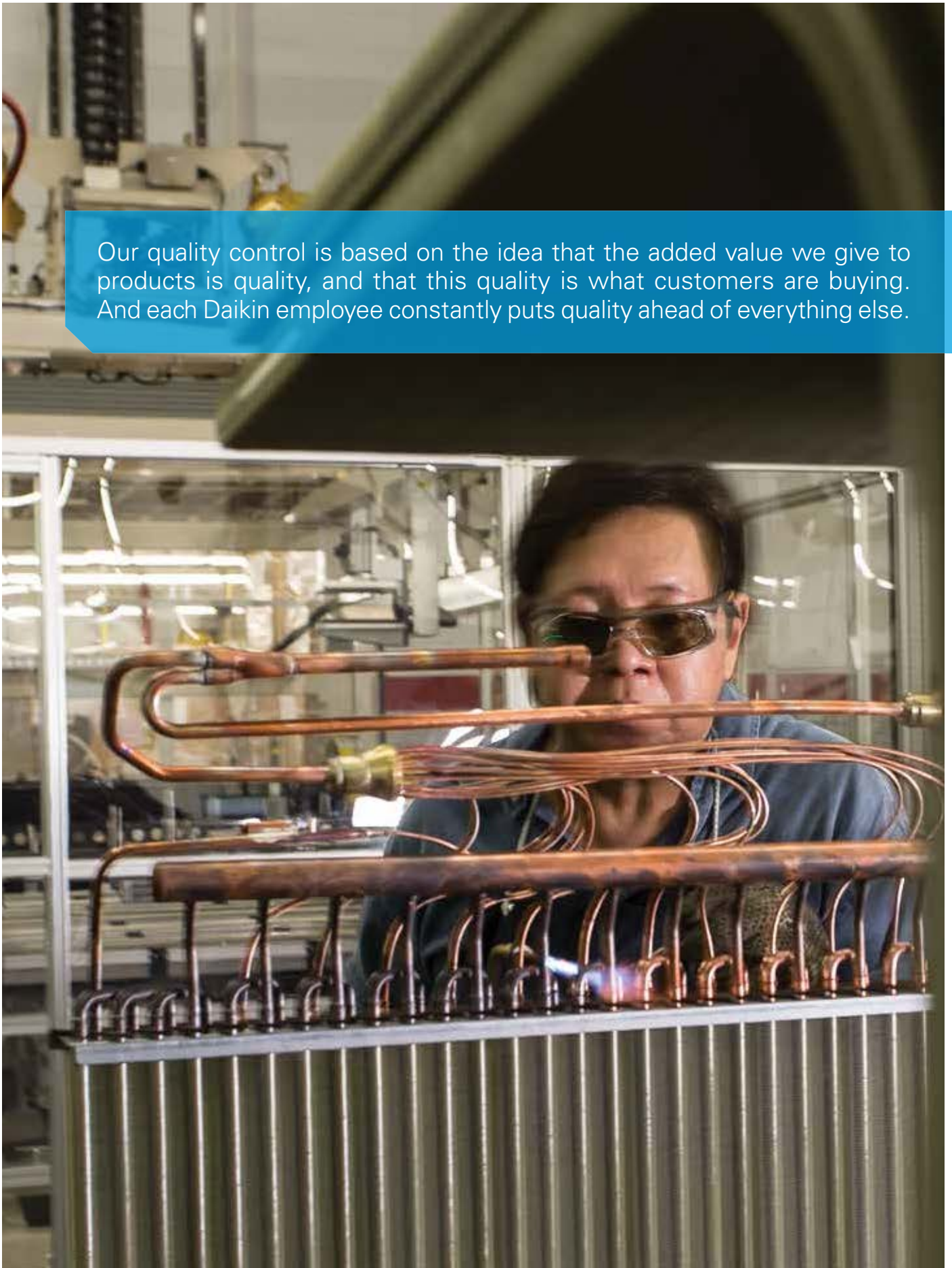

NEW Daikin VRV IV

Setting the standards, again

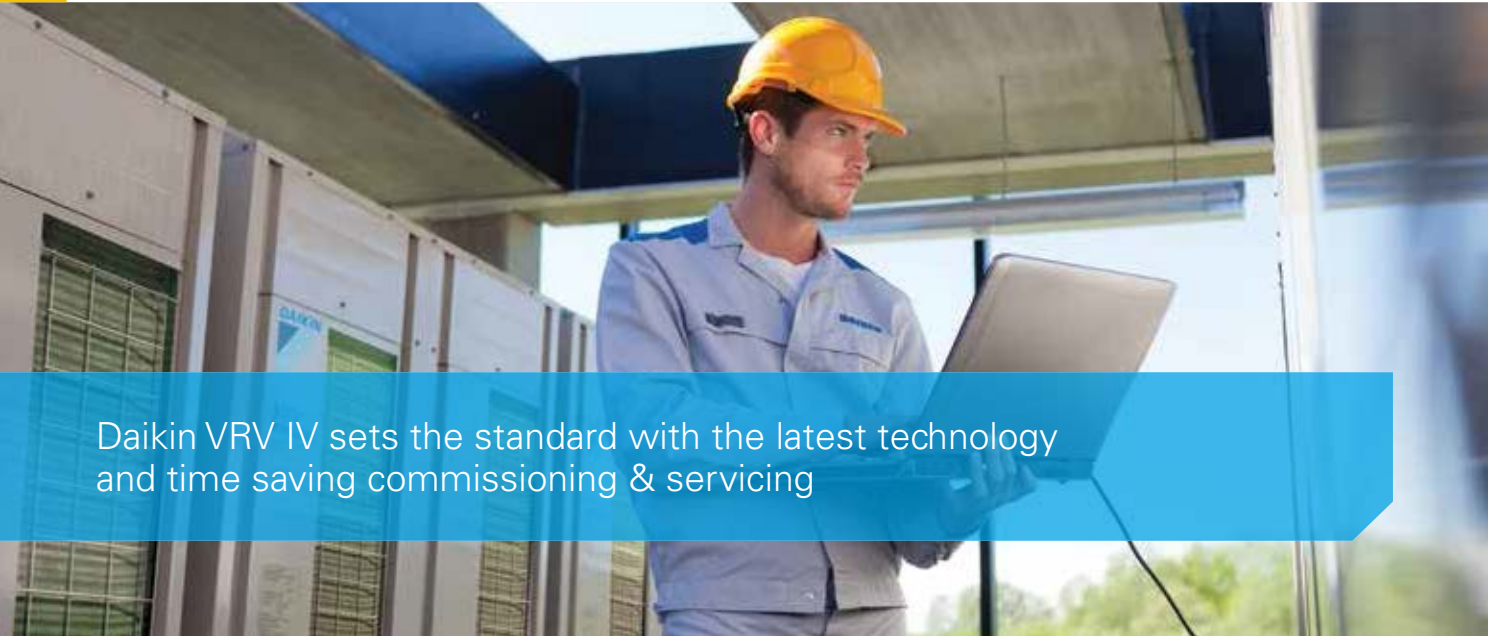

Daikin VRV IV sets the standard with the latest technology and time saving commissioning & servicing

Optimized life cycle cost

The features of a Daikin VRV IV system, energy efficient and easy to design, install, and maintain, means that it is designed to reduce the total life cycle cost.

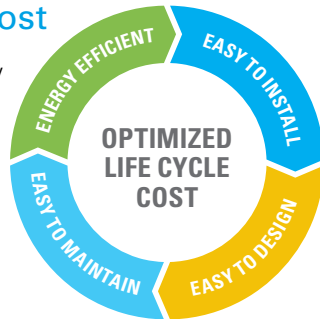

Larger capacity systems saves space

The VRV IV systems reduce installation cost and time as compared to VRV III. We have increased the largest single module to 14 tons and the largest double module to 28 tons, while we made the footprint for the modules smaller. This can mean up to a 32% reduction in installed space compared to VRV III as it is possible to achieve greater capacity with the same or smaller footprint. Again, Daikin has "Set the Standard" by offering a wide system capacity range and giving customers a reduction in installation costs coupled with greater application flexibility.

VRV IV Heat Pump and Heat Recovery - Single, dual, and triple modules

		CAPACITY - TONS																
		6	8	10	12	14	16	18	20	22	24	26	28	30	32	34	36	38
Heat Pump	Heat Pump	Now up to 14 tons — 17% capacity increase*					Now up to 28 tons — 40% capacity increase*						Now up to 34 tons — 13% capacity increase*					
	Heat Recovery	Now up to 14 tons — 17% capacity increase*					Now up to 28 tons — 40% capacity increase*						Now up to 38 tons — 36% capacity increase*					

* Compared to Daikin VRV III models.

Significantly improved energy efficiency

VRV IV combines a number of substantial improvements in system efficiency and function compared to VRV III.

Larger capacity units now utilize new inverter compressors for all configurations. This improves overall efficiency and allows the VRV IV to start with essentially no inrush power. VRV IV uses a four-sided coil that presents a greater heat exchange surface. While allowing the same footprint for all unit sizes for ease of

design, we have increased efficiency through improved heat transfer on all sizes.

The IEER (Integrated Energy Efficiency) for VRV IV Heat Pump is improved over VRV III by an average of 11% with IEER Values now up to 28. For VRV IV Heat Recovery the improvements are even greater with 20% average improvements and IEER Values now up to 29.3.

VRV IV Heat Pump

IEER improved by up to 28% over VRV III — average of 11% over full range

Non - Ducted IEER

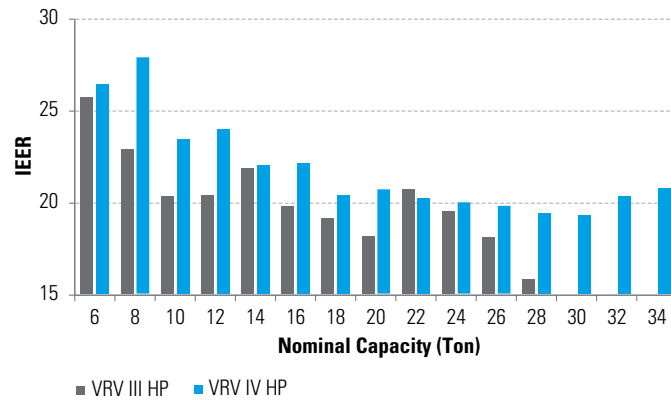

VRV IV Heat Recovery

IEER improved by up to 36% over VRV III — average of 20% over full range

Non - Ducted IEER

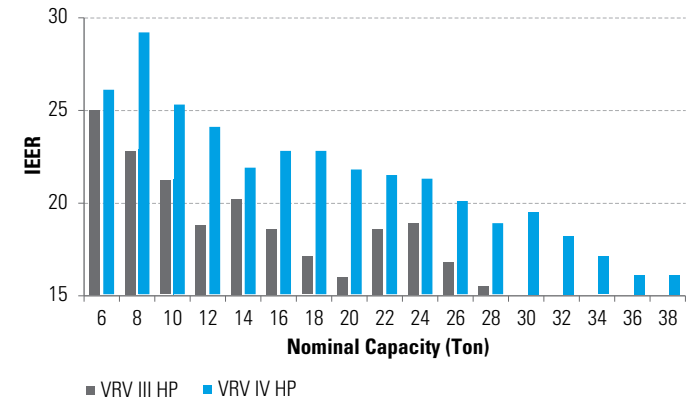

SCHE (Simultaneous Cooling and Heating Efficiency) improved for VRV IV HR by up to 43% over VRV III — Average improvement of 33% over full product size range.



NEW Daikin VRV IV



Setting the standards, again (continued)

The Inventor of VRV is setting the standard again by introducing VRT (Variable Refrigerant Temperature) – State-of-the-art energy-saving technology for VRV

Customize your VRV for optimal annual efficiency

The new VRV IV system now features VRT technology. VRT automatically adjusts refrigerant temperature to individual building and climate requirement, thus further improving annual energy efficiency and maintaining comfort. With this excellent technology, utility costs are reduced.

How is energy reduced?

A standard VRF system, and previous VRV systems, utilize a capacity based control logic where the system will adjust to meet the capacity requirements of the space. With VRT Daikin have optimized to focus not only on capacity but efficiency and comfort.

According to changes in the room heat load and the ambient air temperature, the evaporating temp. (in cooling) and condensing temperature (in heating) are automatically adjusted to minimize

Refrigerant cycle during cooling

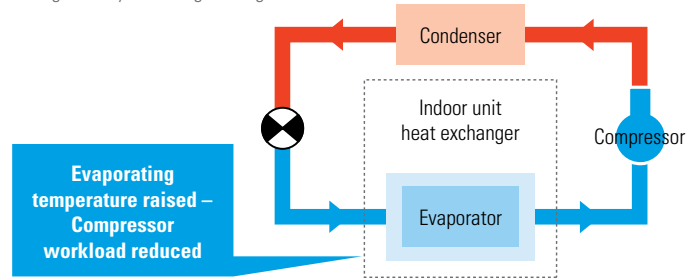

the difference with the condensing temperature and the evaporation temperature, respectively.

This makes the compressors work less and also enables the system to always maintain the ideal compressor speed so that the Daikin VRV system can deliver the optimum efficiency.

Case study – Measured monthly energy usage for a VRV system without VRT and with VRT, installed in a European retail shop

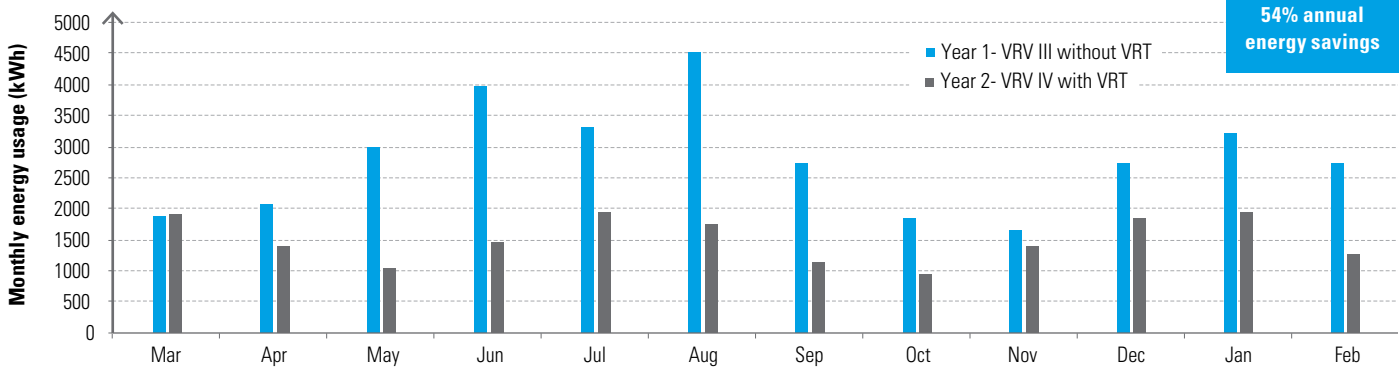

Heating degree days and cooling degree days, that are quantitative indications reflecting demand for energy to heat or cool buildings, were the same for year 1 and year 2.

The basis to determine whether a specific day is a heating degree day or a cooling degree day is the daily average ambient air temperature. Even the average min/max ambient air temperature were very similar for year 1 and year 2.

Ambient air temperature

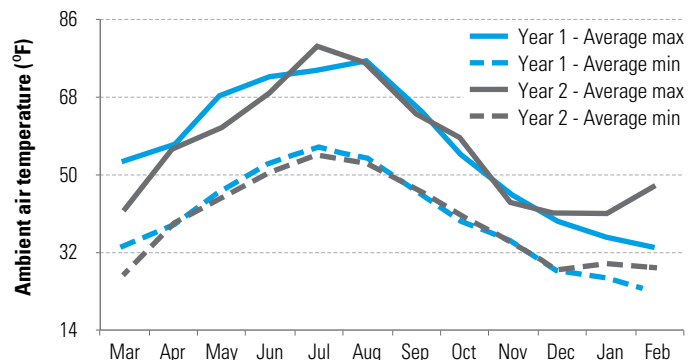

Fine control to match user preference available through mode selection

Basic mode is selected to maintain optimal comfort. VRT is selected to save energy and prevent excessive cooling.

Capacity priority

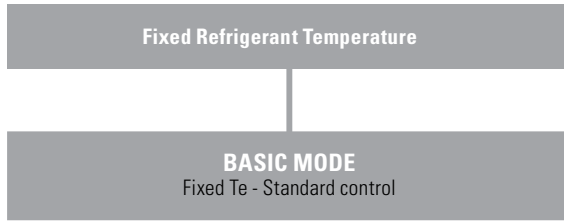

Energy saving priority

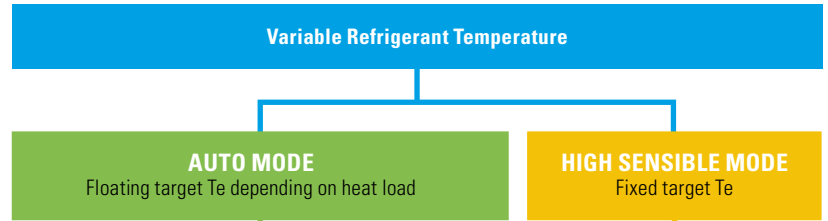

Selecting VRT enables operation to be optimised for either energy efficiency or rapid cooling.

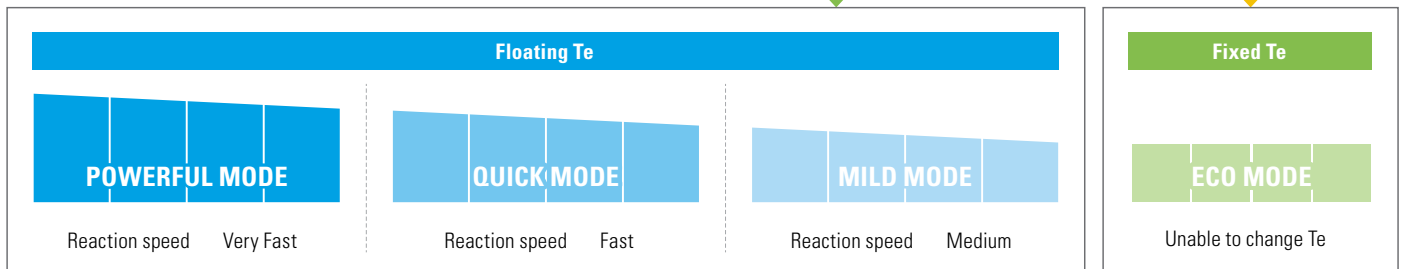

- Can boost capacity above 100% if needed.
The refrigerant temperature can go lower in cooling than the set minimum.
- Gives priority to very fast reaction speed.
The refrigerant temperature goes down fast to keep the room setpoint stable.
- Gives priority to fast reaction speed.
The refrigerant temperature goes down fast to keep the room setpoint stable.
- Gives priority to efficiency.
The refrigerant temperature goes down gradually giving priority to the efficiency of the system instead of the reaction speed.



NEW Daikin VRV IV

Setting the standards, again (continued)

Extended Operation Range — Heating operation down to -13°F outdoor temperature

Daikin VRV IV heat recovery systems can provide heating inside the building even when the outside air temperature is as low as -13°F as standard. Heat pump systems provide heating down to -4°F. This enables enhanced application flexibility and use of the system in colder regions.

Temperature Limits

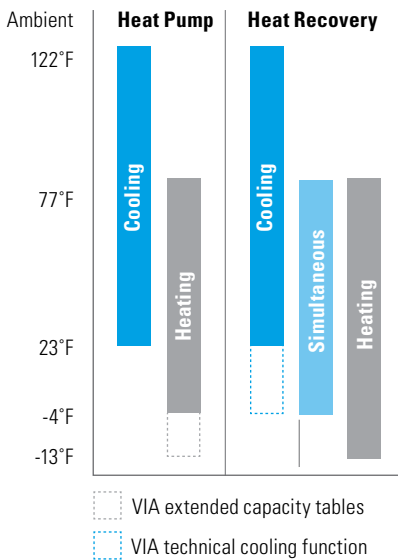

Piping flexibility — More options for installation location

The VRV IV provides very flexible piping possibilities. These generous allowances outlined in the figure facilitate an extensive variety of system designs.

- 100 ft. maximum vertical difference between indoor units provides greater flexibility for riser type piping layouts.
- Allows for up to 12 floors to be served from a single VRV System
- Ideal for mid- to high-rise chiller or WSHP replacement projects

Refrigerant Piping Limitations

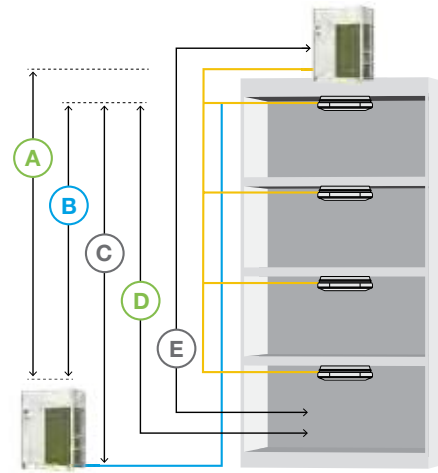

MAXIMUM PIPING DISTANCE	VRV-IV HEAT PUMP	VRV-IV HEAT RECOVERY
A Vertical drop, ft.	164 (295)*	164 (295)*
B Between IDU, ft.	100	100
C Vertical rise, ft.	131 (295)*	131 (195)*
D From 1st joint, ft.	131 (295)**	131 (295)**
E Linear length, ft.	541	541
Maximum total one-way piping length, ft.	3282	3282

*Setting adjustment on condensing unit required.

**IDU distance differentials need to be met

Improved connection ratio flexibility

To properly match outdoor units with indoor units, VRV system designers calculate the connection ratio.

If a system has more combined indoor unit capacity index than combined outdoor unit capacity index, the result is a combination ratio that is greater than 100%. If the outdoor unit combined capacity index is higher than the index for indoor units, the combination ratio is less than 100%.

Most VRF systems do not allow the combination ratio to be more than 130%. However, due to the advanced design of the Daikin VRV IV system, the connection ratio is in most cases allowed to be up to 200%.

This generous connection ratio range enables increased flexibility when a VRV system is designed.

Connection ratio **50%–200%**

$$\text{Connection ratio} = \frac{\text{Total capacity index of the indoor units}}{\text{Total capacity index of the outdoor units}}$$

Conditions of VRV indoor unit connection capacity

APPLICABLE VRV INDOOR UNITS	FXDQ, FXMQ-P, FXAQ MODELS 	OTHER VRV INDOOR UNIT MODELS*
Single outdoor units	200%	200%
Double outdoor units		160%
Triple outdoor units		130%

* For FXFQ07, FXFQ09 and FXTQ models, maximum connection ratio is 130% for the entire range of outdoor units.



NEW Daikin VRV IV

Setting the standards, again (continued)

Advantages of 3-pipe technology

Daikin 3-pipe technology used in heat recovery systems has dedicated refrigerant pipes for suction gas, liquid and discharge gas. The dedicated refrigerant pipes provide smooth and efficient refrigerant flow during all main modes of operation and aid with the heating performance of the system

In a 2-pipe heat recovery system, where the gas and liquid travel as a mixture in the refrigerant pipes, the condensing temperature needs to be higher in order to separate the mixed gas and refrigerant. The higher condensing temperature that is needed means that the compressor has to work harder. In addition, the disturbed refrigerant flow in large pipes on 2-pipe system results in extra pressure drop which can negatively impact the system capacity and efficiency.

NEW Branch selector boxes for ultimate flexibility

Providing flexibility and minimizing mechanical and electrical installation costs, Daikin's branch selector boxes are ideal for spaces that require individual heating and cooling control.

- Extended range of product offerings with 1, 4, 6, 8, 10 and 12 port options
- No drain or condensate consideration required
- Unlimited number of unused ports per box or system
- Reduced electrical and mechanical installation costs
- Ultimate flexibility — choose multi-port or single-port styles to customize your design
- Up to 72% reduction in footprint, as compared to previous generation models
- Up to 17% lower sound levels compared to current VRV III models
- Up to 65% reduction in weight, as compared to previous generation models



New efficient technology from Daikin

Simplified commissioning and after-sales service

VRV IV system utilises a 7-segment display for system operation information, enabling the operational state to be visually displayed whilst facilitating simplified commissioning and after-sales service.



Inverter board cooled by refrigerant circuit

Minimum influence on electronics from ambient temperature.

Section of the coil in the unit is permanently set as condenser for cooling of the inverter board.

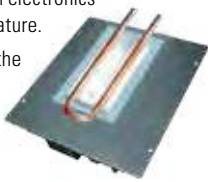

New compressor increases performance

New 6-pole motor
50% stronger magnetic force than 4-pole motor
2% higher efficiency at part load than 4-pole motor

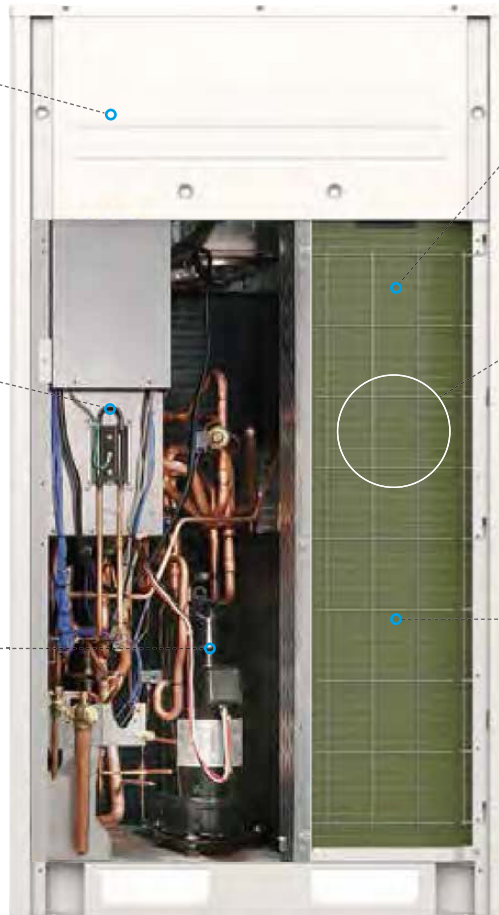

7mm Coil — 3 Row

Improved heat exchanger efficiency



Corrosion protected coil

The VRV IV comes as standard with a corrosion protected coil — 1000 hr of salt fog testing according to ASTM B117.

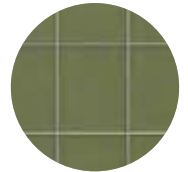

4-sided heat exchanger coil

50% more heat exchanger surface than VRV III — more capacity and higher efficiencies from the same footprint



Inverter board cooled by refrigerant circuit

An inverter Printed Circuit Board (PCB) cooled with the liquid refrigerant circuit increases allows more airflow to the VRV IV cooling coil to increase efficiency and also minimizes any influence on the inverter board from ambient temperatures.

4-Sided heat exchanger coil for efficiency

A 4-sided condenser with up to 3 coil rows utilizing 7 mm tubing means even though the VRV IV has similar footprint as the VRV III, the efficiency is increased while the refrigerant charge is less in most models.

Advanced compressor technology

Daikin J Type Inverter Scroll Compressor has a 50% thinner and a 20% higher scroll blade than the previous generation, which is realized by adapting a newly developed material. This technology increases compression volume by 50%. With the new J Type Compressor and utilizing all inverter compressors, the Maximum Overload Protection (MOP) is reduced by up to 29% compared to VRV III.

50% thinner blade

20% higher blade

50% more compression volume

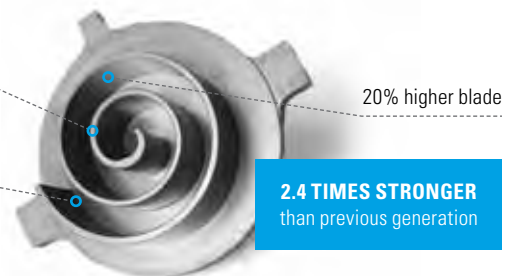

2.4 TIMES STRONGER
than previous generation

NEW Daikin VRV IV

Setting the standards, again (continued)

Outdoor unit sequencing technology

Automatic sequencing operation

During start-up, Daikin VRV IV unit sequencing operation will be automatically enabled to ensure balanced operation of each outdoor unit to improve longevity of equipment and stable operation.



Double backup operation functions responding resiliently to various unexpected situations

Double backup operation functions

Daikin VRV IV system boasts double backup operation functions, which can secure the use of air conditioners in this area to the greatest extent by emergently enabling double backup operation functions even if failure occurs in a set of air conditioning equipment. In the event of a failure, emergency operation can be conveniently enabled to allow the remaining system to operate in a limited fashion.

Unit backup operation function

If malfunction occurs in an outdoor unit...

Emergency operation can be conveniently set and enabled by the remote controller for indoor unit (for systems composed of two or more outdoor units).



Compressor backup operation function

If malfunction occurs in a compressor...

Emergency operation can be easily set and enabled by the outdoor unit.



With the VRV IV heat pump and heat recovery systems, the Daikin brand is one of the most extensive lines of heating and cooling systems in North America.

NEW Daikin VRV IV

Setting the standards, again (continued)

VRV IV outdoor units assembled in the U.S.A.

The VRV IV is the first variable refrigerant flow (VRF) system to be assembled in North America. With a state of the art production line, local / in house preparation, tooling, processing and construction of heat exchangers, refrigerant cycle assemblies,

sheet metal parts, electrical box, etc., we can react quickly to changes in the market-place and truly optimize the product for the North American market.

- Extensive local inventory and short lead times.
- Typically, 98% of replacement parts can be shipped in approximately 48 hours.



VRV system configuration and commissioning

- The VRV configurator is an advanced software solution that allows for easy system configuration and commissioning.
- Less time is required on the roof configuring the outdoor unit.
- Multiple systems at different sites can be managed in exactly the same way, thus offering simplified commissioning for key accounts.
- Initial settings on the outdoor unit can be easily retrieved.



Simplified commissioning

Retrieve initial system settings



Outstanding 10 Year Parts and Compressor Warranty*



Outstanding warranty* with 10 Year Replacement Compressor Limited Warranty and 10 Year Parts Limited Warranty as standard ensures our confidence in our new VRV IV.

*Complete warranty details available from your local Daikin manufacturer's representative or distributor or online at www.daikincomfort.com.

NEW Daikin VRV IV

What does a VRV installation mean to you?

Consulting engineers

Daikin's VRV IV technology maximizes flexibility and leads the way in customization to match individual building requirements in comfort and energy — all designed to reduce the total life cycle costs.

- Maximum flexibility to meet customer requirements
- Advanced software tools assist with system design

Building owners

VRV IV is the ultimate in customized comfort and intelligent control tailored to your individual needs and used to maximize energy efficiency.

- Optimized life cycle cost
- No more cold droughts with variable refrigerant temperature
- Single point of contact for the design of your climate system
- Integrated system, combining air conditioning, heating, ventilation, etc., enables optimized system function
- Multiple systems can be managed in exactly the same way for key accounts
- Dedicated after-sales service to ensure fast on-site support

See how you can profit from Daikin's flexible and efficient product range.

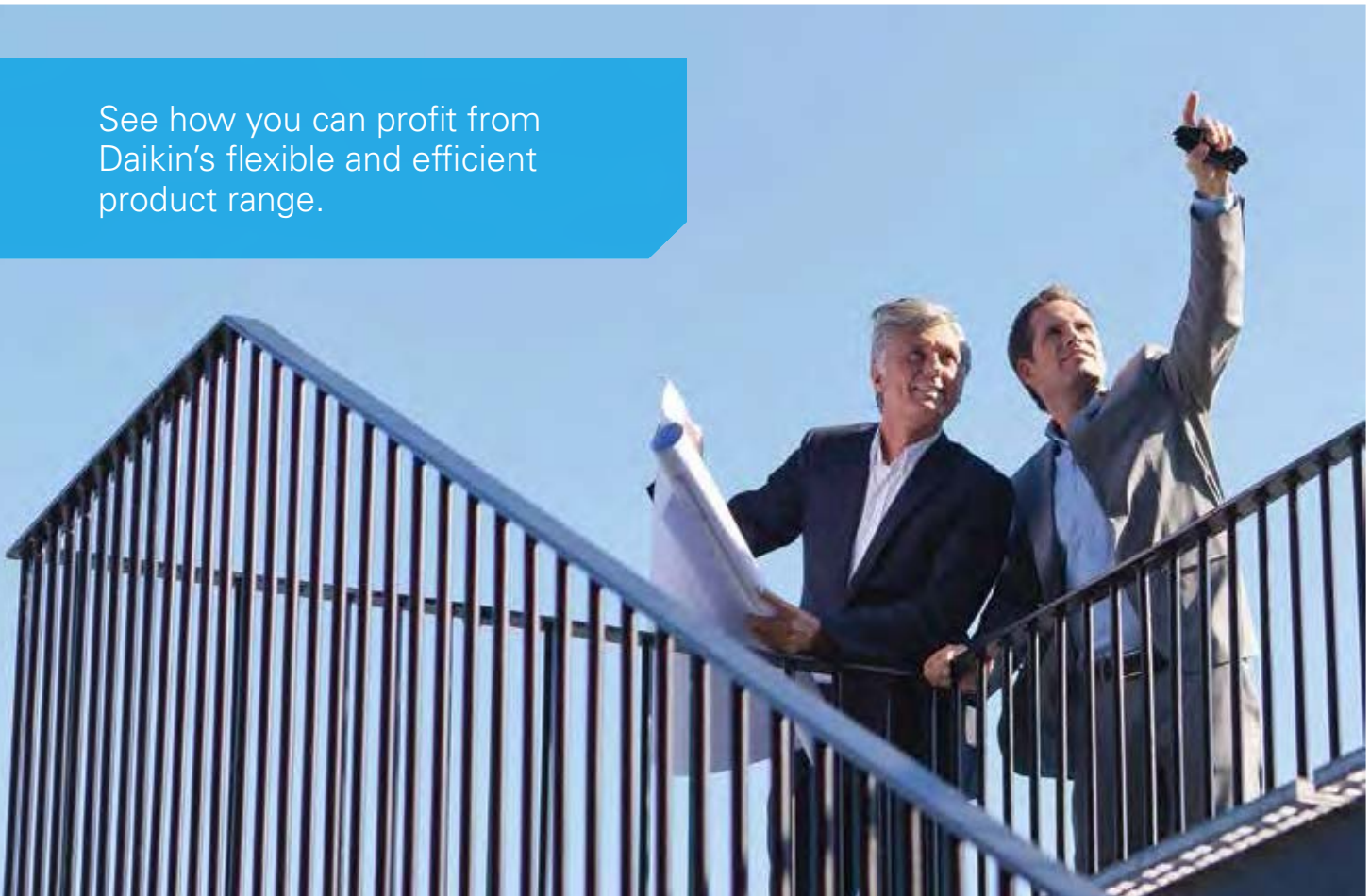

Installers

Daikin VRV IV sets the standard with state-of-the-art technology and time-saving commissioning and servicing.

- Simplified and time-saving commissioning with VRV configurator
- Unique range of single and multi Branch Selector boxes reduce installation time compared to previous generation
- Wide range of outdoor units (up to 38 Tons for heat recovery)
- One supplier equals one point of contact
- Maximum flexibility to meet customer requirements
- Customized training to maximize expertise

Architects

- Indoor units with a sleek and sophisticated design
- Space efficient outdoor units
- Low sound levels for both indoor and outdoor units
- Wide range of indoor units to allow installation in most environments



NEW Daikin VRV IV

Vertical market applications



VRV for offices and banks

Our office solution offers:

- Increased occupant productivity with individual zone control, low sound levels & tight temperature control
- Optimized energy efficiency
- Simple maintenance — low operational cost
- Modular system allowing cost effective out-of-hours operation
- Integrated ventilation solutions allowing high indoor air quality
- Complete Daikin Building Management System for office building management with Intelligent Touch Manager
- Remote monitoring with email alerts
- Self-cleaning filters yielding operational and maintenance cost savings
- Intelligent sensors on round flow cassette maximizing efficiency by innovative occupancy sensing features



VRV for hotels

Our hotel solution offers:

- Energy efficient systems capable of simultaneous heating and cooling.
- Ultra-quiet guest room solutions discrete and simple to control.
- Flexible installation options lowering installation complexity, costs and space requirements than most traditional HVAC systems
- Inverter technology creating the perfect guest room environment by regulating temperature swings and humidity
- Centralized control with the iTouch Manager improving owner / management operational capabilities
- Seamless integration & compatibility with industry acclaimed INNCOM systems delivering combined benefits in guest operations and experience for both guests and management team



VRV for retail and restaurants

Our retail solutions offer:

- Scalable project opportunities with modular design
- Individual zone control for advanced zoning capabilities
- Enhanced efficiency in retail chain operations and energy usage from Daikin's complete Building Management System with Intelligent Touch Manager
- Centralized building control & autonomy from VRV remote commissioning and management capability
- 10 years limited parts and compressor warranty*

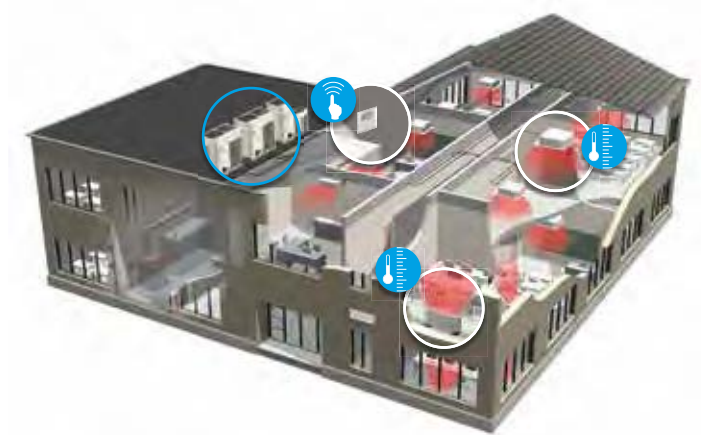

VRV for schools

Our school solution offers:

- Flexible, scalable total HVAC solution for school classrooms, common areas and administrative offices
- Over 12,000 Daikin VRV systems in schools in North America
- Quiet operating sound levels as low as 28 dB(A)
- Minimal occupant air temperature variations
- Advanced zoning capabilities with user-friendly and intuitive controls
- Modular in design accommodating unique school and classroom spaces
- Combined benefits of energy and operations efficiency for both school administrators & maintenance staff
- 10 year limited parts and compressor warranty*

* Complete warranty details available from your local Daikin manufacturer's representative or distributor or online at www.daikincomfort.com.





Product Portfolio

Outdoor units

VRV IV

Heat Recovery

- Fully integrated solution with heat recovery offers high efficiencies with IEER values up to 29.3
- Total comfort solution for heating, cooling, ventilation, and controls
- Outstanding warranty* with 10 year compressor and parts limited warranty as standard
- Perfect personal comfort for guests / tenants via simultaneous cooling and heating
- Incorporates VRV IV standards and technologies such as variable refrigerant temperature and all inverter compressors
- Unique range of single and multi-port branch selector boxes
- Heating function down to -13°F ambient air temperature
- Daikin VRV IV is the first variable refrigerant flow (VRF) system to be assembled in North America.



VRV IV

Heat Pump

- Total comfort solution for heating, cooling, ventilation and controls
- Energy efficiency values (IEER) up to 28.0
- Incorporates VRV IV standards and technologies such as variable refrigerant temperature and all inverter compressors
- Best-In-class warranty* with 10 year compressor and parts limited warranty as standard
- Daikin VRV IV is the first variable refrigerant flow (VRF) system to be assembled in North America.



VRV III

Heat Recovery

- Advanced continuous heating during defrost cycle and oil return for single module systems
- Variable Refrigerant Temperature (VRT) control
- Extended operating range with heating function down to -4°F ambient air temperature



VRV III-S

Air-Cooled

VRV III-S systems are equipped with built-in intelligence which provide independent zoning control with maximum flexibility and energy savings. With the ability to connect up to eight indoor units to one outdoor unit, the space-saving VRV III-S system is ideal for most light commercial and residential applications.



- Single phase technology
- Smaller capacity for precise temperature control
- Space-saving design and flexible indoor unit options offer quick and easy installation
- Superior energy efficiency, especially under part load conditions
- Soft sound levels for comfort
- Single-supplier reliability
- Straightforward maintenance and service with self-diagnostic functions

Condensing unit

VRV IV NEW











*W*Series Water Cooled System

Water Cooled

- Enables geothermal energy as an energy source
- Can be applied to both geothermal and boiler, cooling tower applications
- Geothermal mode eliminates need for an external heating or cooling source
- Compact and lightweight design can be stacked for maximum space saving
- Can be applied to both geothermal and boiler/tower applications as standard with condenser water inlet temperature as low as 14°F in heating and 27°F in cooling is possible



* Complete warranty details available from your local Daikin manufacturer's representative or distributor or online at www.daikincomfort.com.

TYPE	MODEL	FEATURES	PRODUCT NAME	CAPACITY (TONS)																							
				3	4	6	7	8	10	12	14	16	18	20	21	22	24	26	28	30	32	34	36	38			
Air cooled	VRV IV Heat Recovery	<ul style="list-style-type: none"> Best efficiency & comfort solution Fully integrated solution with heat recovery for high efficiencies with IEER of up to 29.3 Covers all thermal needs of a building via a single point of contact for accurate temperature control The perfect personal comfort for guests/tenants via simultaneous cooling and heating Incorporates VRV IV standards & technologies such as Variable Refrigerant temperature and all inverter compressors Widest range of Branch Selector boxes on the market 	REYQ-T VRV IV 			●		●	●	●	●																
														●	●	●	●	●	●								
																				●	●	●	●	●			
	VRV IV Heat Pump	<ul style="list-style-type: none"> Daikin's solution for comfort & low energy consumption Covers all thermal needs of a building via a single point of contact for accurate temperature control 	RXYQ-T VRV IV 			●		●	●	●	●																
														●	●	●	●	●	●								
																			●	●	●						
	VRV III PC Heat Recovery	<ul style="list-style-type: none"> Advanced continuous heating during defrost cycle and oil return for single module systems Variable Refrigerant Temperature (VRT) control Extended operating range with heating function down to -4°F ambient air temperature 	REYQ-PC VRV III 			●		●	●	●*																	
	VRV III-S Heat Pump	<ul style="list-style-type: none"> Single phase technology Space saving solution without compromising on efficiency For residential and light commercial applications 	RXYMQ-PV VRV III-S 		●	●																					
Water cooled	VRV IV W-Series Heat Recovery / Heat Pump	<ul style="list-style-type: none"> Ideal for high rise buildings, using water as heat source Enables use of geothermal energy as a renewable energy source No need for an external heating or cooling source when used in geothermal mode Covers all thermal needs of a building via a single point of contact for accurate temperature control Compact & lightweight design can be stacked for maximum space saving 	NEW RWEYQ-PC VRV IV <small>Water-to-Water-Cooled System</small> 			●	●																				
															●	●											
															●	●											

* 208-230V/3Ph/60Hz only

Product portfolio (continued)

Indoor Units

PRODUCT PORTFOLIO

TYPE	MODEL	FEATURES	PRODUCT NAME
Ducted	DC-Ducted Concealed Ceiling Unit	<ul style="list-style-type: none"> Energy efficient due to the DC fan motor Ideal to use together with the optional Daikin Zoning Kit, DZK Enhanced indoor air quality and LEED ready with MERV 13 filter options Flexible ductwork design with ESP capabilities up to 0.8" W.G. Installation flexibility with a low profile, compact design at less than 12" in height 	FXMQ-PBVJU 
	Slim-Duct, Built-In Concealed Ceiling Unit	<ul style="list-style-type: none"> Slim height, at only 7-7/8" Washable filter included Low sound level Factory shipped for rear air inlet —field convertible to bottom air inlet Condensate pump with vertical lift of up to 21-5/8" included as standard 	FXDQ-MVJU 
	Vertical Air Handling Unit	<ul style="list-style-type: none"> Ideal replacement for fan coils, geothermal heat pumps or traditional splits systems Upflow and horizontal right installation is permitted ECM fan motor provides energy efficiency Wide line up of electric heat (field installed) options from 3kW to 20kW 	FXTQ-PAVJU 
	Concealed Ceiling Unit (Medium Static)	<ul style="list-style-type: none"> Design flexibility with a capacity range up to 96 MBH Improved ductwork and filtration flexibility with high CFM and ESP capabilities Low profile design of less than 19" high to reduce required installation space Ideal for Hotels, Schools, Retail 	FXMQ-MVJU 
	Concealed Floor-Standing Unit	<ul style="list-style-type: none"> Ideal for installation beneath a window Requires minimal installation space Fitted with a washable long-life filter Space-saving unit can be freestanding or wall-mounted 	FXNQ-MVJU9 
Duct-Free	Round Flow Sensing Cassette 	<ul style="list-style-type: none"> True 360° Airflow and three room sensors enables optimized occupant comfort Energy efficient with DC fan motor and auto-logic that adjusts fan speed Optional self-cleaning filter panel to further increase efficiency and reduce maintenance Increased indoor air quality with high efficiency filter options and ventilation connection kit Very flexible with 18 different possible airflow patterns 	FXFQ-TVJU 
	NEW 4-Way Ceiling-Suspended Cassette	<ul style="list-style-type: none"> Very low unit height of under 8" Optional Sensor Kit enables input from three room sensors Stylish unit blends easily with any interior Individual air louver control 	FXUQ-PVJU 
	2' x 2' 4-Way Ceiling-Mounted Cassette	<ul style="list-style-type: none"> Fits in a standard 2' x 2' ceiling grid. Sound pressure levels are as low as 29 dB(A) Space-saving depth of units requires only 11.6" of ceiling space Easy-to-clean grille, washable long-life filter Simple installation with an easy-to-fit decoration panel 	FXZQ-MVJU9 
	NEW Ceiling-Mounted Cassette (Single flow)	<ul style="list-style-type: none"> Only 7-3/8" in height and a width of 18-1/2" making it possible to use this style of indoor unit in the tightest of spaces The unit is equipped with both horizontal and vertical louvers to optimize the airflow and throw to suite your room design The indoor unit can be set to 5 predetermined fan speeds which allows for optimum and comfortable airflow Factory installed condensate pump with a lift capacity of up to 33-7/16" (measured from the bottom of the unit) 	FXEQ-PVJU 
	Ceiling-Suspended Unit	<ul style="list-style-type: none"> One of our slimmest indoor units, less than 8" Wide air discharge outlet distributes a comfortable airflow throughout the entire space Innovative stream fan technology keeps sound pressure levels low Smooth flat louver design makes cleaning simple Long-life filter is standard 	FXHQ-MVJU 
	Wall-Mounted Unit	<ul style="list-style-type: none"> Auto-swing mechanism ensures efficient air distribution via louvers Wide air discharge outlet distributes a comfortable airflow throughout the entire space Horizontal louvers and front panel can be easily removed for cleaning Drain pipe can be easily hidden from sight Compact and stylish design 	FXAQ-PVJU 
	Floor-Standing Unit	<ul style="list-style-type: none"> Ideal for installation beneath a window Unit requires minimal installation space Fitted with a washable long-life filter Remote-control options available Space-saving unit can be freestanding or wall-mounted 	FXLQ-MVJU9 

	CAPACITY													
	MBH	7.5	9.5	12	15	18	24	30	36	42	48	54	72	96
	TON	0.6	0.75	1	1.25	1.5	2	2.5	3	3.5	4	4.5	6	8
	•	•	•	•	•	•	•	•	•		•	•		
	•	•	•			•	•							
			•			•	•	•	•	•	•	•		
													•	•
	•	•	•			•	•							
	•	•	•	•	•	•	•	•	•		•			
						•	•	•	•					
	•	•	•	•	•	•								
	•	•	•	•	•	•								
			•				•		•					
	•	•	•			•	•							
	•	•	•	•	•	•	•							

Product Portfolio (continued)

Accessories

NEW Branch Selector Boxes

Providing flexibility and minimizing mechanical and electrical installation costs, Daikin's branch selector boxes that are used in Heat Recovery systems, are ideal for spaces that require individual heating and cooling control.

NUMBER OF BRANCHES / MAXIMUM TOTAL CAPACITY INDEX (KBTU/H)							
							
BSQ36TVJ 1/36	BSQ60TVJ 1/60	BSQ96TVJ 1/96	BS4Q54TVJ 4/144	BS6Q54TVJ 6/216	BS8Q54TVJ 8/290	BS10Q54TVJ 10/290	BS12Q54TVJ 12/290

REFNET

REFNET Joints distribute correct flow of refrigerant in every branch of the piping network.



REFNET Joint



REFNET Header

VRV IV Heat Pump

OPTIONAL ACCESSORIES		RXYQ72T RXYQ96T	RXYQ120T RXYQ144T RXYQ168T	RXYQ192T RXYQ216T RXYQ240T RXYQ264T RXYQ288T RXYQ312T RXYQ336T	RXYQ360T RXYQ384T RXYQ408T
Distributed piping	Refnet Header	KHRP26M22H (max. 4 branch) KHRP26M33H (max. 8 branch)	KHRP26M22H (max. 4 branch) KHRP26M33H (max. 8 branch) KHRP26M72H (max. 8 branch)	KHRP26M22H (max. 4 branch) KHRP26M33H (max. 8 branch) KHRP26M72H (max. 8 branch) KHRP26M73H (max. 8 branch)	KHRP26M22H (max. 4 branch) KHRP26M33H (max. 8 branch) KHRP26M72H (max. 8 branch) KHRP26M73H (max. 8 branch)
	Refnet Joint	KHRP26A22T KHRP26A33T	KHRP26A22T KHRP26A33T KHRP26M72TU	KHRP26A22T KHRP26A33T KHRP26M72TU KHRP26M73TU	KHRP26A22T KHRP26A33T KHRP26M72TU KHRP26M73TU
Outdoor unit multi connection piping kit		—		BHFP22P100U	BHFP22P151U

VRV IV Heat Recovery

OPTIONAL ACCESSORIES		REYQ72T REYQ96T	REYQ120T REYQ144T REYQ168T	REYQ192T REYQ216T REYQ240T REYQ264T REYQ288T REYQ312T REYQ336T	REYQ360T REYQ384T REYQ408T REYQ432T REYQ456T
Distributed piping	Refnet Header	KHRP26M33H (max. 8 branch)	KHRP26M33H (max. 8 branch) KHRP26M72H (max. 8 branch)	KHRP25M33H9 (max. 8 branch) KHRP25M72H9 (max. 8 branch) KHRP25M73H9 (max. 8 branch)	KHRP25M33H9 (max. 8 branch) KHRP25M72H9 (max. 8 branch) KHRP25M73H9 (max. 8 branch)
	Refnet Joint	KHRP25A22T9 KHRP25A33T9	KHRP25A22T9 KHRP25A33T9 KHRP25M72TU9	KHRP25A22T9 KHRP25A33T9 KHRP25M72TU9 KHRP25M73TU9	KHRP25A22T9 KHRP25A33T9 KHRP25M72TU9 KHRP25M73TU9
Outdoor unit multi connection piping kit		—		BHFP26P100U	BHFP26P151U

VRV III PC Heat Recovery

OPTIONAL ACCESSORIES		REYQ72PC	REYQ96PC REYQ120PC REYQ144PCTJ
Distributed piping	Refnet Header	KHRP25M33H9 (max. 8 branch)	KHRP25M33H9 (max. 8 branch) KHRP25M72H9 (max. 8 branch)
	Refnet Joint	KHRP25A22T9 KHRP25A33T9	KHRP25A22T9 KHRP25A33T9 KHRP25M72TU9

VRV IV W-Series Heat Pump / Heat Recovery and VRV-III-S

UNIT MODEL NUMBER	VRV IV W-SERIES			VRV-III-S
	RWEYQ72P RWEYQ84P	RWEYQ144P RWEYQ168P	RWEYQ168P RWEYQ252P	RXYMQ36P RXYMQ48P
REFNET Header	KHRP25M33H9 (max. 8 branch) KHRP26M22H9 (max. 4 branch) KHRP26M33H9 (max. 8 branch)	KHRP25M33H9 (max. 8 branch) KHRP25M72H9 (max. 8 branch) KHRP26M22H9 (max. 4 branch) KHRP26M33H9 (max. 8 branch) KHRP26M72H9 (max. 8 branch)	KHRP25M33H9 (max. 8 branch) KHRP25M72H9 (max. 8 branch) KHRP25M73HU9 (max. 8 branch) KHRP26M22H9 (max. 4 branch) KHRP26M33H9 (max. 8 branch) KHRP26M72H9 (max. 8 branch) KHRP26M73HU9 (max. 8 branch)	KHRP26M22H9 (max. 4 branches) KHRP26M33H9 (max. 8 branches)
REFNET Joint	KHRP25M22T9 KHRP25M33T9 KHRP26M22T9 KHRP26M33T9	KHRP25M22T9 KHRP25M33T9 KHRP25M72TU9 KHRP26M22T9 KHRP26M33T9 KHRP26M72TU9	KHRP25M22T9 KHRP25M33T9 KHRP25M72TU9 KHRP25M73TU9 KHRP26M22T9 KHRP26M33T9 KHRP26M72TU9 KHRP26M73TU9	KHRP26M22T9
Outdoor Unit Multi Piping Connection Kit (Heat Pump)		BHFP22MA56U	BHFP22MA84U	
Outdoor Unit Multi Piping Connection Kit (Heat Recovery)		BHFP26MA56U	BHFP26MA84U	

NEW Hail Guard Kit for VRV IV

The optional hail guard kit for VRV IV enables optimal airflow for efficient heat transfer while providing condenser coil protection from hail damage in severe climates. Each hail guard kit, that is field installed, consists of 4 panels (Right, Left, Front and Back).



KIT PART NUMBER	QUANTITY OF KITS PER VRV IV OU MODEL				
	R_YQ72T	R_YQ96-168T	R_YQ192T	R_YQ216-336T	R_YQ360-456T
VRV4HGS-K1	1	1	1		
VRV4HGL-K1			1	2	3

Product Portfolio (continued)

Accessories (continued)

DZK (Daikin Zoning Kit)



The optional DZK increases the flexibility of the Daikin VRV and SkyAir systems in both residential and commercial applications by adding a Zoning Box to an indoor unit fan coil (FXMQ-P or FBQ-P series, respectively) allowing several separate ducts to supply air to different individually controlled zones.

	DZK030E4	DZK030E5	DZK048E4	DZK048E6	DZK-MTS	DZK-ZTS
Number of Air Duct Outlets x Diameter (*)	4 x Ø8	5 x Ø6	4 x Ø8	6 x Ø6	–	–

Daikin VRV controls

Optimized for VRV technology, Daikin controls provide highly scalable solutions for all applications and budgets. VRV controls offer solutions to meet your project controls needs from individual zone control with local controllers to centrally controlling the building with Centralized Controllers and/or interfacing with Building Management Systems (BMS) for comfort control in an easily managed and operated system.

PROJECT REQUIREMENTS	DAIKIN VRV CONTROLS						
	 Navigation Remote Controller	 Simplified Remote Controller	 intelligent Touch Controller	 intelligent Touch Manager	 BACnet Interface	 LonWorks Interface	 Modbus Interface
Individual zone control	●	●					
Independent cool and heat setpoints	●		●	●			
Individual zone control with weekly programmable scheduling	●		●	●			
Basic central point on/off control of all air handling units			●	●	●	●	●
Advanced multi-zone control of small to medium size projects			●	●	●	●	●
Advanced multi-zone control of large commercial projects			●	●	●	●	
Advanced multi-zone control with scheduling logic and calendar			●	●			
Automatic cooling/heating changeover for heat pump systems	●		●	●			
Single input batch shutdown of all connected air handlers			●	●	●	●	■
Web browser control and monitoring via Intranet and Internet			●	●	■	■	■
E-mail notification of system alarms and equipment malfunctions			●	●	■	■	■
Multiple tenant power billing for shared condenser applications			●	●			
Temperature set-point range restrictions	●		●	●	■	■	■
Graphical user interface with floor plan layout				●	■	■	■
Start/stop control of ancillary building systems*			●	●	■	■	■
Daikin VRV integration with BACnet® based automation systems					●		
Daikin VRV integration with LonWorks® based automation systems						●	
Daikin VRV integration with Modbus based automation systems							●

* Requires one or more DEC102A51-US2 Digital Input/Output units or WAGO DO module (for use with iTM only).

● Native application or feature for this device. ■ Dependent upon capabilities of the third party energy management system





The configurable display and operation buttons on the Navigation Remote Controller will provide as much or as little control as the installed VRV system requires.



Product Portfolio (continued)

Accessories (continued)

Network solutions



TYPE		ITC	ITM	LONWORKS	BACnet	MODBUS
						
Screen	Layout screen		●			
	Touch screen	●	●			
Integration	Mini BMS for heating, air conditioning applied systems and refrigeration units (BACnet and WAGO)		●			
	3rd party equipment integration (BACnet and WAGO)		●			
Control	Basic control functions: on/off, set point setting, air flow settings, operation mode	●	●	●	●	●
	Temperature limitation	●	●			
	Setback		●			
	Automatic changeover	●	●			
	Weekly schedule and special day pattern	●	●			
	Timer extension		●			
	Forced off	●	●	●	●	
Monitoring	Basic control functions: ON/OFF status, operation mode, set point temp.	●	●	●	●	●
	Filter status	●	●	●	●	●
	Malfunction code	●	●	●	●	●
	History (operation, malfunction...)	●	●			
	Visualization	●	●			
Options	PPD	●	●			
	Web access and control	●	Std			
	HTTP option	●				
Other	Interlock	●	●			
	Maximum number of indoor unit groups	2 x 64	7 x 64	64	4 x 64	16

Air treatment systems

Daikin's Outside Air Processing Unit can combine fresh air treatment and air conditioning, supplied from a single system.

The compact Energy Recovery Ventilator is designed to improve indoor air quality while reducing the overall HVAC system power

consumption. This is achieved by providing fresh outside air and recovering waste heat from exhaust air leaving the conditioned space.

		OUTSIDE AIR PROCESSING UNIT, FXMQ-MFVJU	ENERGY RECOVERY VENTILATOR, VAM-GVJU
			
VRV Refrigerant Piping		Connectable	Not connectable
VRV Control Wiring		Connectable	
High Efficiency Filter (MERV 8 and MERV 13)		Option	Not available
Ventilation System		Air supply	Air supply and Air exhaust
Power Supply	V/ph/Hz	208-230/1/60	
Airflow Rate	CFM	635 988 1236	300/300/170 470/470/390 600/600/500 1200/1200/930



Daikin's air treatment systems — creating a better air quality environment.





Indoor Units



Indoor units

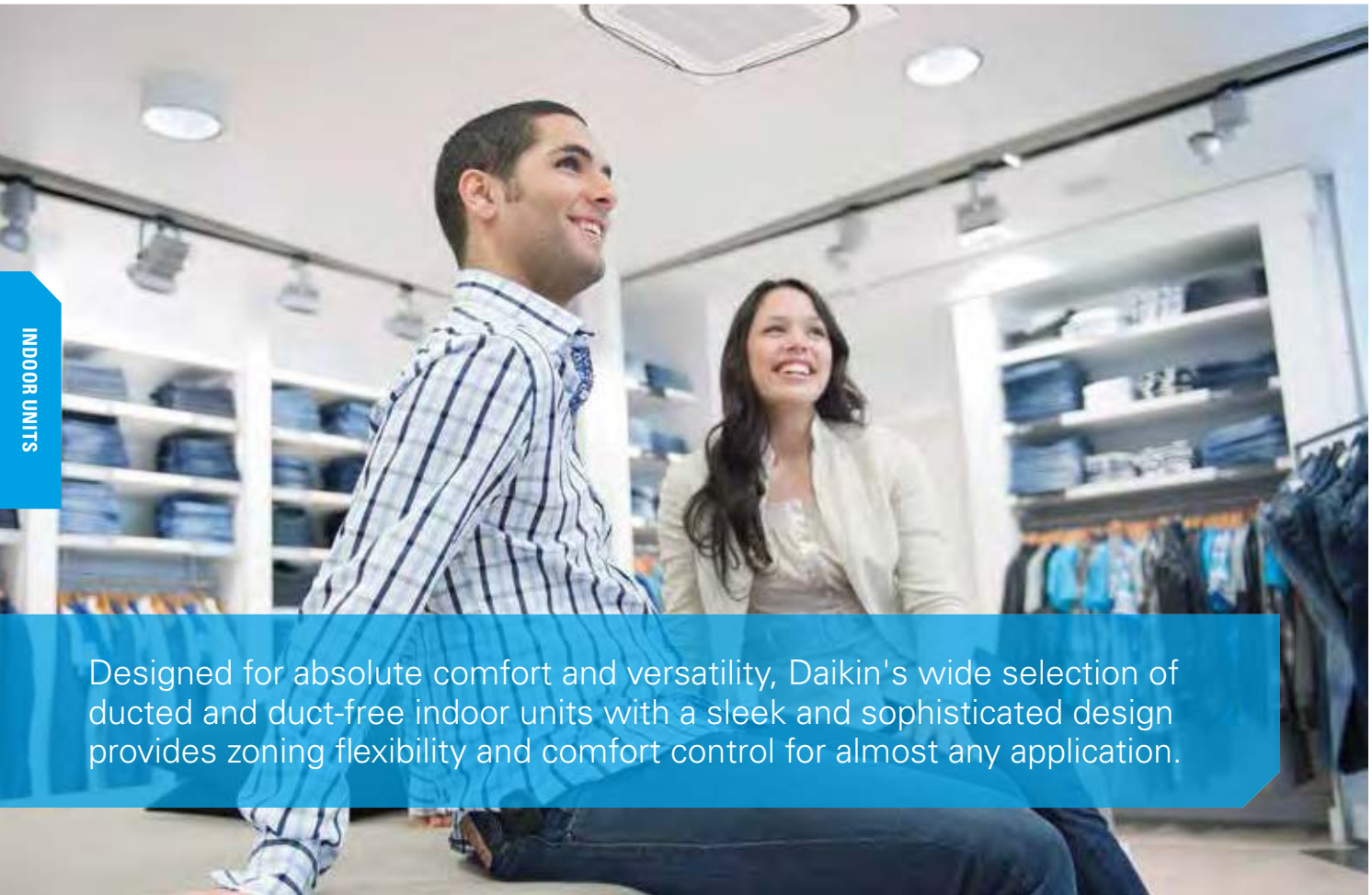

Designed for absolute comfort and versatility, Daikin's wide selection of ducted and duct-free indoor units with a sleek and sophisticated design provides zoning flexibility and comfort control for almost any application.

As many as 64 separate indoor units can be connected to a refrigerant circuit with a single outdoor unit of up to 38 tons capacity. The Daikin VRV indoor unit range is one of the widest on the market, offering no less than 12 stylish and elegant indoor units types in 63 different models — all designed to maximize comfort, minimize operating sound and simplify installation and servicing.

Indoor unit models include round flow ceiling mounted cassette, ceiling concealed ducted, ceiling suspended, wall mounted and floor standing models.

The Round Flow sensing cassette now includes an optional VRF industry first self-cleaning filter, which automatically cleans itself daily (user adjustable), leading to yearly energy savings of up to

50%. Dust from the filter is collected in the unit for easy and quick removal (when indicated) with a standard vacuum cleaner.

Designed to fit rooms of any size and shape, Daikin indoor units are also user friendly, ultra reliable, easy to control and quiet in operation.

INDOOR UNIT TYPE	CAPACITY														
	MBH TONS	7.5 0.6	09 0.75	12 1	15 1.25	18 1.5	24 2	30 2.5	36 3	42 3.5	48 4	54 4.5	72 6	96 8	
DUCTED	FXMQ-PBVJU DC-Ducted Concealed Ceiling (Medium Static)		▲ 🔌 🌬️	▲ 🔌 🌬️	▲ 🔌 🌬️	▲ 🔌 🌬️	▲ 🔌 🌬️	▲ 🔌 🌬️	▲ 🔌 🌬️	▲ 🔌 🌬️		▲ 🔌 🌬️	▲ 🔌 🌬️		
	FXDQ-MVJU Slim Duct Built-In Concealed Ceiling Unit		▲ 🔌 🌬️	▲ 🔌 🌬️	▲ 🔌 🌬️		▲ 🔌 🌬️	▲ 🔌 🌬️							
	FXTQ-PAVJU Vertical Air Handling Unit (Horizontal RHS is Possible)				▲ 🌬️		▲ 🌬️	▲ 🌬️	▲ 🌬️	▲ 🌬️	▲ 🌬️	▲ 🌬️	▲ 🌬️		
	FXMQ-MVJU Concealed Ceiling Unit (Medium Static)													▲ 🌬️	▲ 🌬️
	FXNQ-MVJU9 Concealed Floor- Standing Unit		▲ 🌬️	▲ 🌬️	▲ 🌬️		▲ 🌬️	▲ 🌬️							
DUCT-FREE	FXFQ-TVJU Round Flow Sensing Cassette, Ceiling Mounted	 ROUND FLOW	▲ 🔌 🌬️	▲ 🔌 🌬️	▲ 🔌 🌬️	▲ 🔌 🌬️	▲ 🔌 🌬️	▲ 🔌 🌬️	▲ 🔌 🌬️	▲ 🔌 🌬️		▲ 🔌 🌬️			
	NEW FXUQ-PVJU 4-Way Blow Ceiling-Suspended Cassette						▲ 🔌	▲ 🔌	▲ 🔌	▲ 🔌					
	FXZQ-MVJU9 2' X 2' 4-Way Ceiling-Mounted Cassette		▲ 🔌 🌬️	▲ 🔌 🌬️	▲ 🔌 🌬️	▲ 🔌 🌬️	▲ 🔌 🌬️								
	NEW FXEQ-PVJU Ceiling-Mounted Cassette (Single Flow)		▲ 🔌 🌬️	▲ 🔌 🌬️	▲ 🔌 🌬️	▲ 🔌 🌬️	▲ 🔌 🌬️	▲ 🔌 🌬️							
	FXHQ-MVJU Ceiling-Suspended Unit				▲			▲		▲					
	FXAQ-PVJU Wall-Mounted Unit		▲	▲	▲		▲	▲							
	FXLQ-MVJU9 Floor-Standing Unit		▲ 🌬️	▲ 🌬️	▲ 🌬️		▲ 🌬️	▲ 🌬️							

▲ Comfort cooling/heating (11 types 57 models) 🔌 Condensate pump standard 🌬️ Outside air connection possible

Indoor units overview

What are your choices?

FXMQ-PBVJU DC-Ducted Concealed Ceiling (Medium Static)

Ceiling mounted DC-Ducted unit — ideal for small to large spaces in need of a concealed air-conditioning system.



FXMQ-MVJU Concealed Ceiling Unit (Medium Static)

Ideal unit for larger open space floor plans usually found in offices, retails, hotels or education facilities.



FXDQ-MVJU Slim Duct Built-In Concealed Ceiling Unit

Slim duct built-in concealed unit with low profile and low sound level.



FXNQ-MVJU9 Concealed Floor- Standing Unit

Floor-standing unit that can easily be installed along a perimeter wall — or concealed.



FXTQ-PAVJU Vertical Air Handling Unit (Horizontal RHS is Possible)

Vertical air handling unit ideal for both residential and light commercial applications. It has both upflow and horizontal right installation possibilities.



FXFQ-TVJU Round Flow Sensing Cassette, Ceiling Mounted

Ideal for open plan applications such as classrooms and offices where adaptive comfort control is preferred. Provides excellent comfort level, energy efficiency, and flexibility due to advanced control functions.



NEW

FXUQ-PVJU
4-Way Blow Ceiling-Suspended Cassette

Perfect solution for rooms without a false ceiling, or minimal space above a false ceiling, where adaptive comfort control is preferred.



FXAQ-PVJU
Wall-Mounted Unit

Unit ideal for cooling or heating smaller zones such as stores, offices and restaurants. Compact and stylish design.



FXZQ-MVJU9
2'x2' 4-Way Ceiling-Mounted Cassette

2'x2' 4-way Cassette best for open plan applications such as classrooms, offices and retail.



FXLQ-MVJU9
Floor-Standing Unit

Great way to save space. The floor-standing units can easily be installed along a perimeter wall.



NEW

FXHQ-MVJU
Ceiling-Suspended Unit

Ceiling-suspended with slim and elegant design.



FXEQ-PVJU
Ceiling-Mounted Cassette (Single Flow)

Slim and compact design for installation flexibility. For hotel rooms, offices and residential.



DC-Ducted Concealed Ceiling Unit (Medium Static)



Condensate Pump
as Standard

Outside Air
Integration Possible

Powerful, Concealed, Flexible

The ceiling mounted DC-Ducted unit is ideal for small to large spaces in need of a concealed air-conditioning system. It is extremely powerful and the compact design allows it to be completely concealed. This makes it perfect for retail, classrooms, offices, banks, restaurants, shops and hotels common areas.

Features and Benefits

- Capacity range up to 54 MBH.
- Energy efficient due to the DC fan motor
- Ideal to use together with the optional Daikin Zoning Kit, DZK
- Configurable auxiliary heater control logic
- Advanced economizer control logic
- Enhanced indoor air quality and LEED ready with MERV 13 filter options
- Ease of installation with auto adjusting airflow at commissioning based on external static pressure
- Flexible ductwork design with ESP capabilities up to 0.8" W.G.
- Installation flexibility with a low profile, compact design at less than 12" in height
- Easy maintenance with complete service access from below
- Option to permanently turn off the condensate pump via field settings



BRC1E73 (option)



BRC2A71 (option)



BRC4C82 (option)

Auto Adjust External Static Pressure

- After installation, it is possible that the actual duct resistance is lower than expected at the time of designing. As a consequence, the air-flow will be too high.
- With the automatic air-flow adjustment function the unit can adapt its fan speed to a lower curve, so the air-flow decreases.
- The air-flow will always be within 10% of the rated air-flow because of the amount of possible fan curves (more than 8 fan curves available per model).
- Alternatively the installer can manually select a fan curve with the wired remote control.

Auto Adjust External Static Pressure

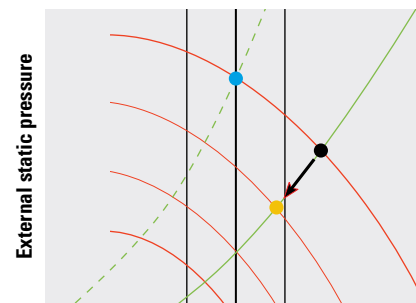

- Fan characteristic curve
- Actual duct resistance curve
- - - Duct resistance curve at the time of designing
- Rated airflow
- Airflow with out airflow automatic adjustment
- Actual airflow

INDOOR UNITS

Applications

- Offices
- Hotels
- Schools
- Retail

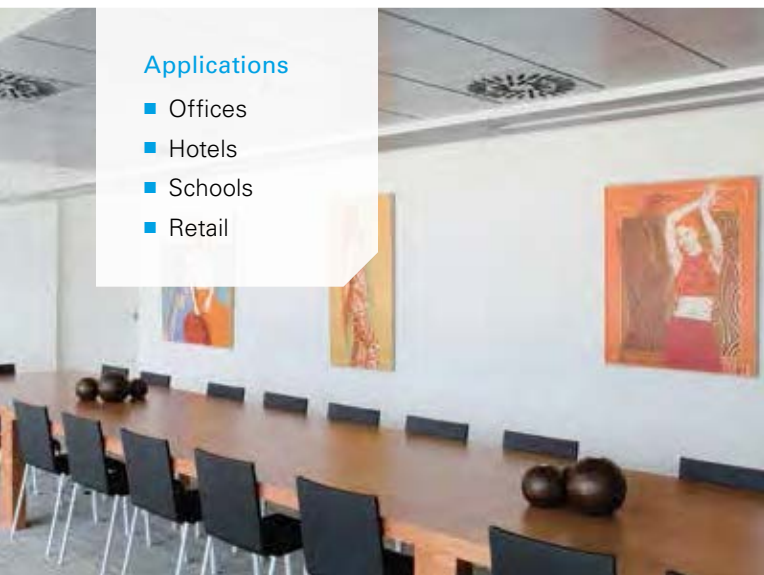

FXMQ-PBVJU SPECIFICATIONS		0.6 TON	0.75 TON	1.0 TON	1.25 TON	1.5 TON	2.0 TON	2.5 TON	3.0 TON	4.0 TON	4.5 TON	
Model Name		FXMQ07PBVJU	FXMQ09PBVJU	FXMQ12PBVJU	FXMQ15PBVJU	FXMQ18PBVJU	FXMQ24PBVJU	FXMQ30PBVJU	FXMQ36PBVJU	FXMQ48PBVJU	FXMQ54PBVJU	
Power Supply	V/ph/Hz	208-230/1/60										
Rated Cooling Capacity	BTU/h	7,500	9,500	12,000	15,000	18,000	24,000	30,000	36,000	48,000	54,000	
Rated Heating Capacity	BTU/h	8,500	10,500	13,500	17,000	20,000	27,000	34,000	40,000	54,000	60,000	
Airflow Rate (H/M/L)	CFM	317/264/229		450/410/388	560/530/500	635/582/529	688/618/565	1,094/953/812	1,130/953/812	1,377/1,165/988	1,624/1,377/1,130	
Height	in.	11-3/16										
Width	in.	21-5/8		27-9/16	39-3/8			55-1/8				
Depth	in.	27-9/16										
Condensate Pump Lift	in.	18-3/8										
Sound Pressure (H/M/L)	dB(A)	33/31/29		39/37/35	40/38/37	41/39/37	42/40/38	43/41/39		44/42/40	46/45/43	
Condensate Pipe Connection	in. O.D.	1-1/4										
Pipe Connections	Gas	in. 1/2 (Flare)							5/8 (Flare)			
	Liquid	in. 1/4 (Flare)							3/8 (Flare)			
Refrigerant		R-410A										
Refrigerant Control		Electronic Expansion Valve										
Maximum Overcurrent Protective Device	A	15										
Minimum Circuit Amps	A	0.6		1.4	1.5	1.6	1.8	2.8	2.9		3.4	
Protection Devices		Fuse and Fan Driver Overload Protector										
External Finish		Galvanized Steel Plate										
External Static Pressure (H/L)	in. W.G.	0.40/0.12								0.80/0.20		0.56/0.20

MERV 13 Filter Kit Option contains a MERV 13 filter, adapter frame and easy to follow installation instructions and can be installed on the following models only:

Kit Model	Indoor Unit
DACA-FXMQ12131K	FXMQ07-09PBVJU
DACA-FXMQ14131K	FXMQ12PBVJU
DACA-FXMQ30131K	FXMQ15-24PBVJU
DACA-FXMQ48131K	FXMQ30-54PBVJU

ENTHALPY ECONOMIZER (FIELD APPLIED ACCESSORY)

Model	Indoor Unit
ECONMQ12P-8-1K (MERV 8 Filter)	FXMQ07-09PBVJU
ECONMQ12P-13-1K (MERV 13 Filter)	
ECONMQ30P-8-1K (MERV 8 Filter)	
ECONMQ30P-13-1K (MERV 13 Filter)	FXMQ15-24PBVJU
ECONMQ48P-8-1K (MERV 8 Filter)	
ECONMQ48P-13-1K (MERV 13 Filter)	

FXMQ-PBVJU ACCESSORIES

Model Name	FXMQ07PBVJU	FXMQ09PBVJU	FXMQ12PBVJU	FXMQ15PBVJU	FXMQ18PBVJU	FXMQ24PBVJU	FXMQ30PBVJU	FXMQ36PBVJU	FXMQ48PBVJU	FXMQ54PBVJU	
Navigation Remote Controller*						BRC1E73					
Simplified Wired Remote Controller*						BRC2A71					
Wireless Remote Controller						BRC4C82					
Remote Sensor Kit						KRCS01-4B					
Wiring Adapter PCB (interface with aux/primary heater, humidifier, OA damper/fan)						KRP1C74					
Group Control Adapter PCB (connects to external BMS)						KRP4A71					

*Optional face plates available to provide a more intuitive user interface and disable specific functions

FXMQ-PBVJU INSTALLATION SPACE

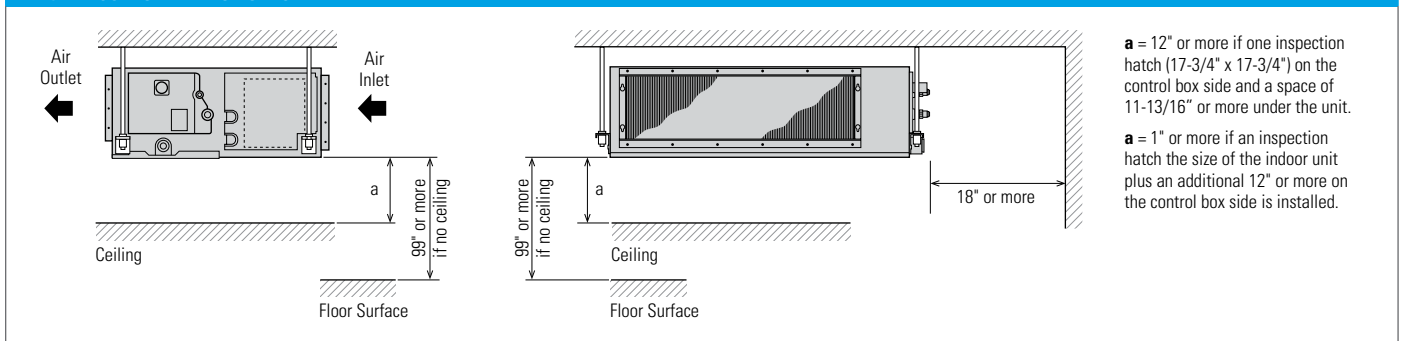

DC-Ducted Concealed Ceiling Unit (Medium Static)

Kits and Accessories



The optional Daikin Zoning Kit (DZK) increases the flexibility of the Daikin VRV and SkyAir systems by adding a Zoning Box to an indoor unit fan coil (FXMQ-P or FBQ-P series, respectively) allowing several separate ducts to supply air to different individually-controlled zones in the building. A zone can be a room, part of room, or several rooms. This flexible and scalable Zoning Kit integrates seamlessly with the indoor unit fan coil controls. The DZK system controls work together with the regular Daikin zone controller (i.e. BRC1E73) to establish the required set-point, fan speed and mode of operation that is then requested to the VRV indoor unit via the Daikin zone controller. This allows the internal DZK control algorithms to look at the number of zone dampers in operation, and at what position the dampers need to be and adjust the VRV indoor unit operation accordingly. The DZK system is not directly compatible with the suite of Daikin centralized control options such as iTM and iTC.

A complete Daikin Zoning Kit consists of Zoning Box (with Control Board), Wired Thermostat, and Wireless Thermostats. The optional DZK BACnet Gateway Module enables any BACnet/IP compatible Building Management System to be used for remote monitoring and control of the DZK.

Wired Thermostat

The Wired Thermostat in the DZK is a graphical colored, touch-screen interface with text menus, intuitive icons, and guided scheduling capability. It displays temperatures and operating values, and selects the operating mode for the system.



Wireless Thermostat

The wireless backlit touch-screen thermostat in the DZK can control the temperature for a zone while displaying the air temperature, system time, and day of the week. Additional functions include adjusting set point temperature, automatic configuration, local ventilation activation, and vacation mode. A wireless thermostat is required for zones not being controlled by a wired thermostat.



Now with BACnet/IP compatibility



Zoning Box with Control Box (Model Depends on Indoor Unit)

The Zoning Box in the Daikin Zoning Kit mounts easily on Daikin's Indoor Unit FXMQ-P or FBQ-P series fan coils. It consists of the enclosure, individually motorized dampers, and a control box. It is available in different sizes and damper configurations and by utilizing ducts for air supply it can be used to control the air temperature in up to 6 zones. The wired thermostat and the wireless thermostats provide temperature inputs and user interfaces for programming and adjustment of the control functions for each zone.



DZK BACnet Gateway Module **NEW**

If VRV systems are installed with the DZK system to accomplish a variety of zoning solutions and there is a requirement to be able to monitor and control the various DZK zone dampers from a centralized control system, it is possible to utilize the DZK BACnet Gateway module to address this solution.



The DZK BACnet Gateway module will work with any BACnet/IP compatible Building Management System.

DAIKIN ZONING KIT (DZK) – KIT STRUCTURE AND GENERAL TECHNICAL DATA

	Zoning Box with Control Box				Wired Thermostat*	Wireless Thermostat*	BACnet Gateway	Heat Pump Changeover Master
DZK Product Number	DZK030E4, DZK030E4-2*	DZK030E5, DZK030E5-2*	DZK048E4, DZK048E4-2*	DZK048E6, DZK048E6-2*	DZK-MTS-1-W, DZK-MTS-2-W*	DZK-ZTS-1-W, DZK-ZTS-2-W*	DZK-BACNET-2	DZK-CM-1
Kit Structure								
Compatible with Indoor Unit Fan Coils - FXMQ15-24PBVJU - FBQ18-30PVJU	Yes		No					Yes
Compatible with Indoor Unit Fan Coils - FXMQ30-54PBVJU - FBQ36-42PVJU	No		Yes					Yes
Number of Zones Compatibility	Maximum 4	Maximum 5	Maximum 4	Maximum 6	-	-	-	-
Number of Air Duct Outlets x Diameter (")	4 x Ø8	5 x Ø6	4 x Ø8	6 x Ø6	-	-	-	-
Required Quantity	One Per Indoor Unit Fan Coil DZK030E4-2 Required For BACnet/IP	One Per Indoor Unit Fan Coil DZK030E5-2 Required For BACnet/IP	One Per Indoor Unit Fan Coil DZK048E4-2 Required For BACnet/IP	One Per Indoor Unit Fan Coil DZK048E6-2 Required For BACnet/IP	Minimum One Per Indoor Unit Fan Coil DZK-MTS-2-W Required For BACnet/IP	Number Of Zones Minus Number Of Wired Thermostats DZK-ZTS-2-W Required For BACnet/IP	One Per DZK Zoning Box With BACnet/IP	One Per VRV HP System, If 2 To 16 DZK Units (without BACnet) In The Same VRV System
Technical Data								
Height (")	10.43				3.58		1.6	1.75
Width (")	43.58		53.46		4.13		2.7	2.32
Depth (")	10.43				0.94		1.2	0.67
Weight (lb.)	18.04	20.24	23.32		0.4	0.46	0.063	0.065
Input Voltage	110/230 VAC				12 VDC, from Zoning Box	2 AAA Batteries	12 VDC, from Control Board	12 VDC, from Zoning Box
Full Load Amps (A)	0.25				-	-	-	-

*"-2" in the Product Number indicates that the product has BACnet/IP functionality. For configuration of DZK systems with BACnet/IP functionality, only Product Numbers ending with "-2" or "-2-W" can be used. For configuration of DZK systems without BACnet, either products with, or without, the BACnet functionality can be used, even "mix and match".

INDOOR UNITS

CONTROLS CONNECTION OF FXMQ-PBVJU AND DZK (WITHOUT BACNET)

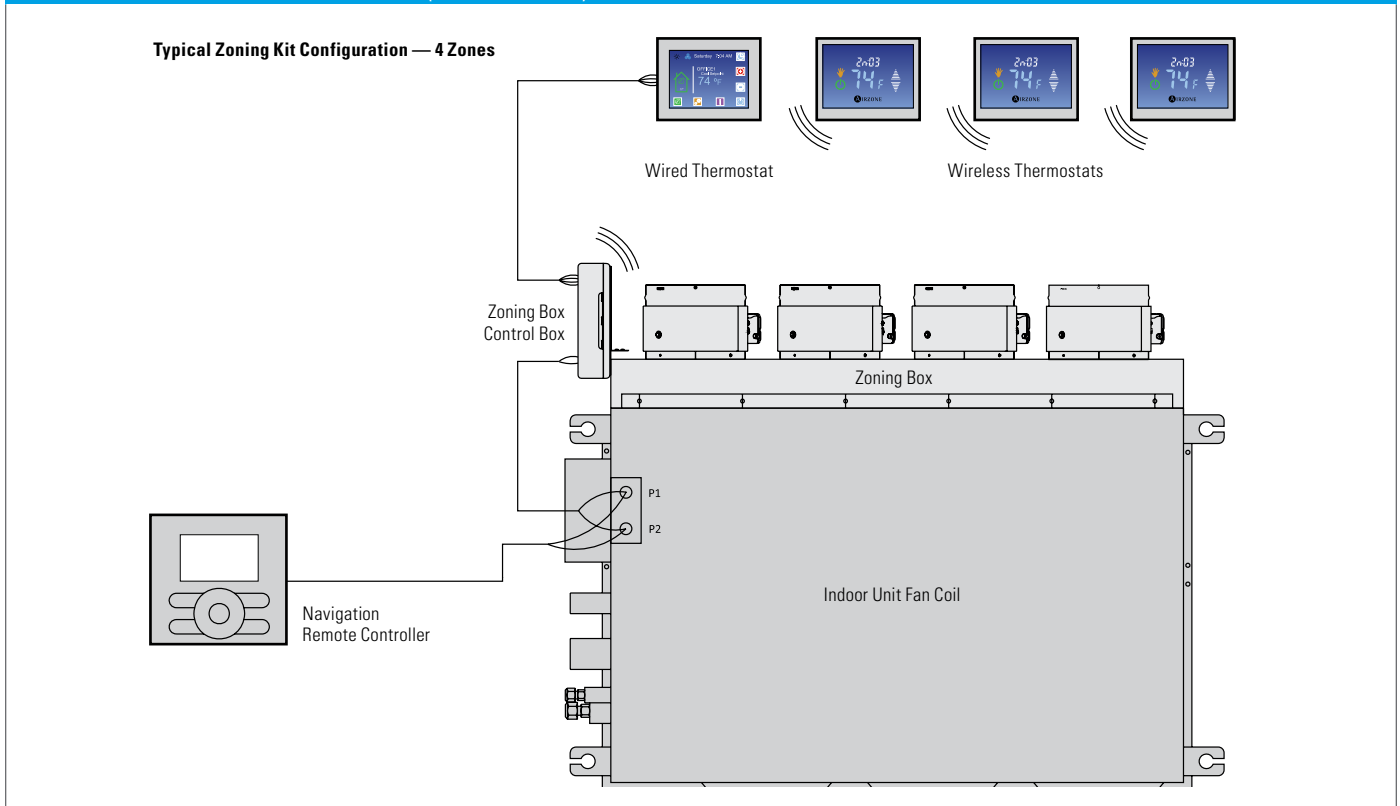

Slim-Duct, Built-In Concealed Ceiling Unit



Condensate Pump
as Standard



Outside Air
Integration Possible



Filter
Included

Concealed, Slim, Quiet, Comfortable

The slim duct built-in concealed unit is available for use with the VRV systems to complement the existing concealed ceiling unit options. With its low profile and low sound level this unit can be installed into limited ceiling void, bulkhead or soffit space.



BRC1E73 (option)



BRC2A71 (option)



BRC4C82 (option)

Features and Benefits

- Slim height, at only 7-7/8", makes it suitable for most of the applications where attic / bulkhead space is limited
- With a sound level down to 29 dB(A) these units are among the quietest on the market
- Factory shipped for rear air inlet — field convertible to bottom air inlet
- Washable filter included
- Condensate pump with vertical lift of up to 21-5/8" included as standard
- Blends unobtrusively with any interior decor; only the suction and discharge grills are visible

Applications

- Hotel rooms
- Multi-family residences
- Single family residences
- School dormitories



INDOOR UNITS

FXDQ-MVJU SPECIFICATIONS			0.6 TON	0.75 TON	1 TON	1.5 TONS	2 TONS
Model Name			FXDQ07MVJU	FXDQ09MVJU	FXDQ12MVJU	FXDQ18MVJU	FXDQ24MVJU
Power Supply	V/ph/Hz		208-230/1/60				
Rated Cooling Capacity	BTU/h		7,500	9,500	12,000	18,000	24,000
Rated Heating Capacity	BTU/h		8,500	10,500	13,500	20,000	27,000
Airflow Rate (H/L)	CFM		280/226			440/350	580/460
Weight	lbs		51			63	71
Height	in.		7-7/8				
Width	in.		27-9/16			35-7/16	43-5/16
Depth	in.		24-7/16				
Sound Pressure (H/L)	dB(A)		33/29			35/31	36/32
Condensate Pump Lift	in.		21-5/8				
Condensate Pipe Connection	in. O.D.		1-1/32				
Pipe Connections	Gas	in.	1/2 (Flare)				5/8 (Flare)
	Liquid	in.	1/4 (Flare)				3/8 (Flare)
Refrigerant			R-410A				
Refrigerant Control			Electronic Expansion Valve				
Maximum Overcurrent Protective Device	A		0.9			1.3	1.4
Minimum Circuit Amps	A		15				
Protection Devices			Fuse and Fan Motor Thermal Protector				
External Finish			Galvanized Steel Plate				
Standard Filter Type			Removable, Washable, Mildew Proof				
External Static Pressure (H/L)	in. W.G.		0.12/0.04			0.17/0.06	0.17/0.06

Nominal Conditions:

Cooling Mode
 Indoor: 80 °F DB / 67 °F WB
 Outdoor: 95 °F DB
 Pipe Length: 25 ft.
 Level Difference: 0 ft.

Heating Mode
 Indoor: 70 °F DB
 Outdoor: 47 °F DB / 43 °F WB
 Pipe Length: 25 ft.
 Level Difference: 0 ft.

Note: Specifications are subject to change without notice.

FXDQ-MVJU ACCESSORIES						
Model Name		FXDQ07MVJU	FXDQ09MVJU	FXDQ12MVJU	FXDQ18MVJU	FXDQ24MVJU
Navigation Remote Controller*				BRC1E73		
Simplified Wired Remote Controller*				BRC2A71		
Wireless Remote Controller				BRC4C82		
Remote Sensor Kit				KRCS01-1B		
Wiring Adapter PCB (interface with aux/primary heater, humidifier, OA damper/fan)				KRP1C75		
Group Control Adapter PCB (connects to external BMS)				KRP4A74		
Access Panel (single door)			APFXDQ070912		APFXDQ18	APFXDQ24
Access Panel with return air filter (single door)			APRFFXDQ070912		APRFFXDQ18	APRFFXDQ24
Filter Media Replacement			APRFFXDQ070912F		APRFFXDQ18F	APRFFXDQ24F

* Optional face plates available to provide a more intuitive user interface and disable specific functions

FXDQ-MVJU INSTALLATION SPACE

Choose an installation site that ensures both optimum air distribution and sufficient clearance for maintenance.

The return air inlet can be easily changed from rear to bottom using the same chamber lid.

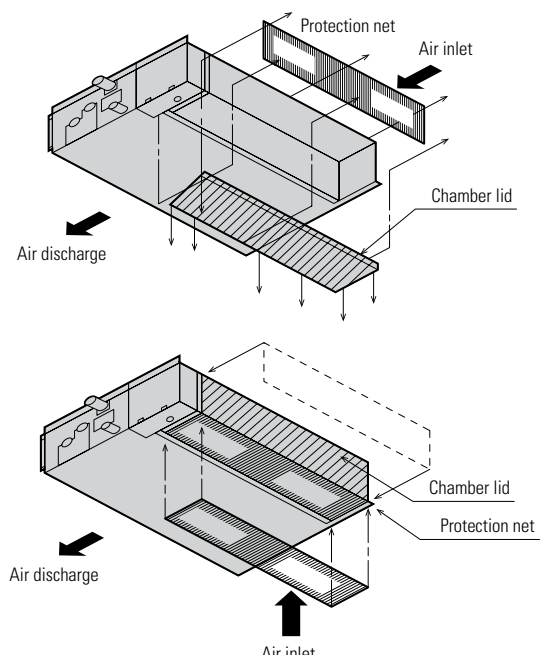
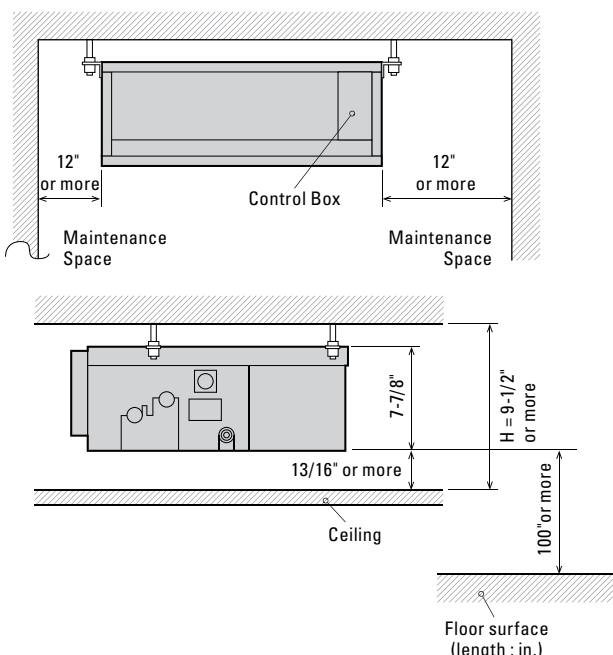

Vertical Air Handling Unit



Outside Air
Integration Possible

Concealed, Powerful, Compact, Comfortable

The vertical air handling unit is designed for use with all Daikin VRV systems, allowing more flexibility and combination possibilities. With a capacity range from 12 to 54 MBH and both upflow and horizontal right installation possibilities, the unit is ideal for both residential and light commercial applications.

Features and Benefits

- Ideal replacement for fan coils, geothermal heat pumps or traditional splits systems
- Can be used in new construction or replacement projects
- Ability to mix and match with other Daikin indoor units on the same system
- Reduced piping cost with smaller piping diameters
- Upflow and horizontal right installation is permitted
- 2 selectable fan speeds (H and L)
- New fan logic allowing the unit to be commissioned where the fan operation will cycle on and off with the load
- ECM fan motor provides energy efficiency
- Wide line up of electric heat (field installed) options from 3kW to 20kW
- Plug-in electric heat control minimizes equipment and installation cost
- Possibility to operate electric heater in combination with heat pump



BRC1E73 (option)



BRC4C82 (option)



BRC2A71 (option)

Electric Heater Options

ELECTRICAL HEATER CAPACITY							
Model Name	3kW	5kW	6kW	8kW	10kW	15kW	20kW
FXTQ12PAVJU	■	■	×	×	×	×	×
FXTQ18PAVJU	●	■	■	×	×	×	×
FXTQ24PAVJU	●	■	■	■	■	×	×
FXTQ30PAVJU	●	●	■	■	■	×	×
FXTQ36PAVJU	●	●	■	■	■	×	×
FXTQ42PAVJU	●	●	●	●	■	■	◆
FXTQ48PAVJU	●	●	●	●	■	■	◆
FXTQ54PAVJU	●	●	●	●	■	■	◆

● Electric heater operation with heat pump is allowed

× N/A

◆ Acceptable 2 step heating operation

■ Only electric heater operation is allowed

Applications

- Offices
- Hotels
- Multi-family residences
- Single-family residences



FXTQ-PAVJU SPECIFICATIONS		1 TON	1.5 TON	2 TON	2.5 TON	3 TON	3.5 TON	4 TON	4.5 TON
Model Name		FXTQ12PAVJU	FXTQ18PAVJU	FXTQ24PAVJU	FXTQ30PAVJU	FXTQ36PAVJU	FXTQ42PAVJU	FXTQ48PAVJU	FXTQ54PAVJU
Power Supply	V/ph/Hz	208-230/1/60							
Rated Cooling Capacity	BTU/h	12,000	18,000	24,000	30,000	36,000	42,000	48,000	54,000
Rated Heating Capacity	BTU/h	13,500	20,000	27,000	34,000	40,000	47,000	54,000	60,000
Airflow Rate (H/L)	CFM	400/280	600/420	800/560	1,000/700	1,200/840	1,400/980	1,600/1,120	1,800/1,260
Weight	lbs	119		145			167		
Height	in.	46-3/4					53-1/4		
Width	in.	19-1/2					22		
Depth	in.	22					24		
Condensate Pipe Connection		in. O.D.		3/4 (fpt)					
Pipe Connections	Gas	in. 1/2 (Braze)					5/8 (Braze)		
	Liquid	in. 1/4 (Braze)					3/8 (Braze)		
Refrigerant		R-410A							
Refrigerant Control		Electronic Expansion Valve							
Maximum Overcurrent Protective Device	A	15							
Minimum Circuit Amps	A	1.1	1.9	1.6	2.4	3.3	4.0	6.0	8.0
Protection Devices		Fuse and Fan Motor Thermal Protector							
External Finish		Fully insulated, painted steel cabinet with gray finish							
External Static Pressure Range		in. W.G.		0.3 Standard, 0.5 Max					

Nominal Conditions:

Cooling Mode

Indoor: 80 °F DB / 67 °F WB
 Outdoor: 95 °F DB
 Pipe Length: 25 ft.
 Level Difference: 0 ft.

Heating Mode

Indoor: 70 °F DB
 Outdoor: 47 °F DB / 43 °F WB
 Pipe Length: 25 ft.
 Level Difference: 0 ft.

Note: Specifications are subject to change without notice.

FXTQ-PAVJU ACCESSORIES

Model Name	FXTQ12PAVJU	FXTQ18PAVJU	FXTQ24PAVJU	FXTQ30PAVJU	FXTQ36PAVJU	FXTQ42PAVJU	FXTQ48PAVJU	FXTQ54PAVJU
Navigation Remote Controller ¹					BRC1E73			
Simplified Wired Remote Controller ²					BRC2A71			
Wireless Remote Controller					BRC4C82			
Remote Sensor Kit					KRCS01-4B			
Group Control Adapter PCB (connects to external BMS)					KRP4A742			
External Control Adapter for Outdoor Unit					DTA104A532			
Fixing Box					KRP1B1013			
Air Filter	FIL 36-42					FIL 48-61		
Insulation Kit (vertical)	DPI 36-42/20					DPI 48-61/20		
Insulation Kit (horizontal)	DPIH 36-42					DPIH48-61		

¹ Need 24VAC power supply ² Need 16VDC power supply ³ Fixing box installed beside the unit

^{*} Optional face plates available to provide a more intuitive user interface and disable specific functions

FXTQ-PAVJU INSTALLATION SPACE

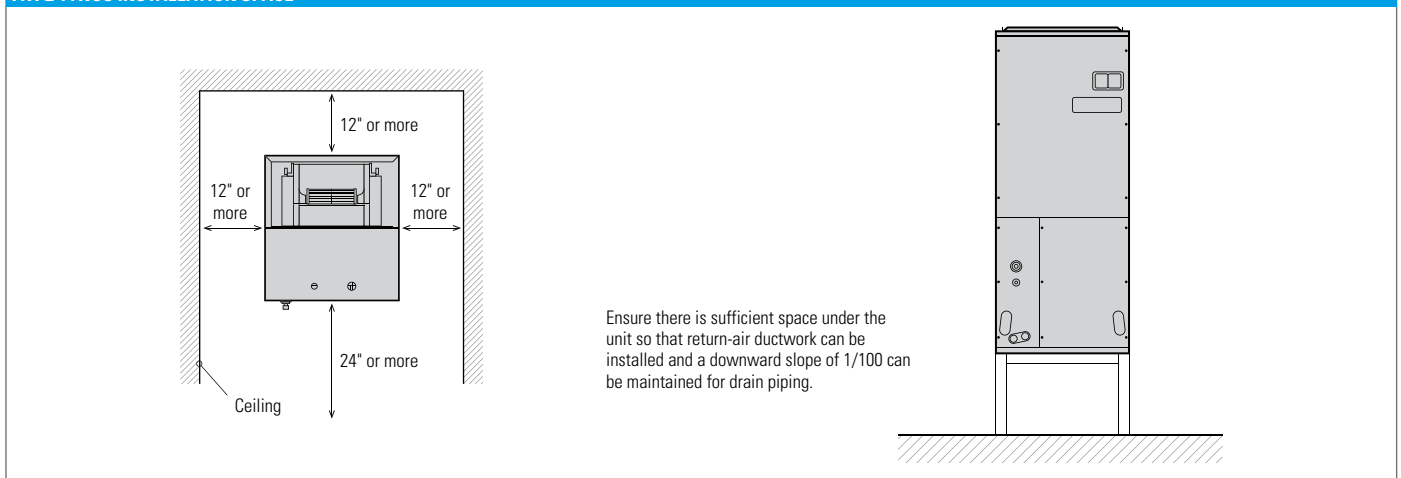

INDOOR UNITS

Concealed Ceiling Unit (Medium Static)



Outside Air
Integration Possible

Concealed, Slim Design, Strong, Comfortable

The FXMQ-MVJU ducted fan coil unit is ideal for larger open space floor plans usually found in offices, retails, hotels, or education facilities. It performs well across multiple spaces that can benefit from the same mode of operation, limiting equipment and installation cost.



BRC1E73 (option)



BRC2A71 (option)



BRC4C82 (option)

Features and Benefits

- Design flexibility with a capacity range up to 96 MBH
- Improved ductwork and filtration flexibility with ESP capabilities of up to 1.1" W.G.
- Low profile design of less than 19" high to reduce required installation space

Applications

- Hotel/conference centers
- Schools
- Retail/shopping centers
- Large open-plan offices
- Churches

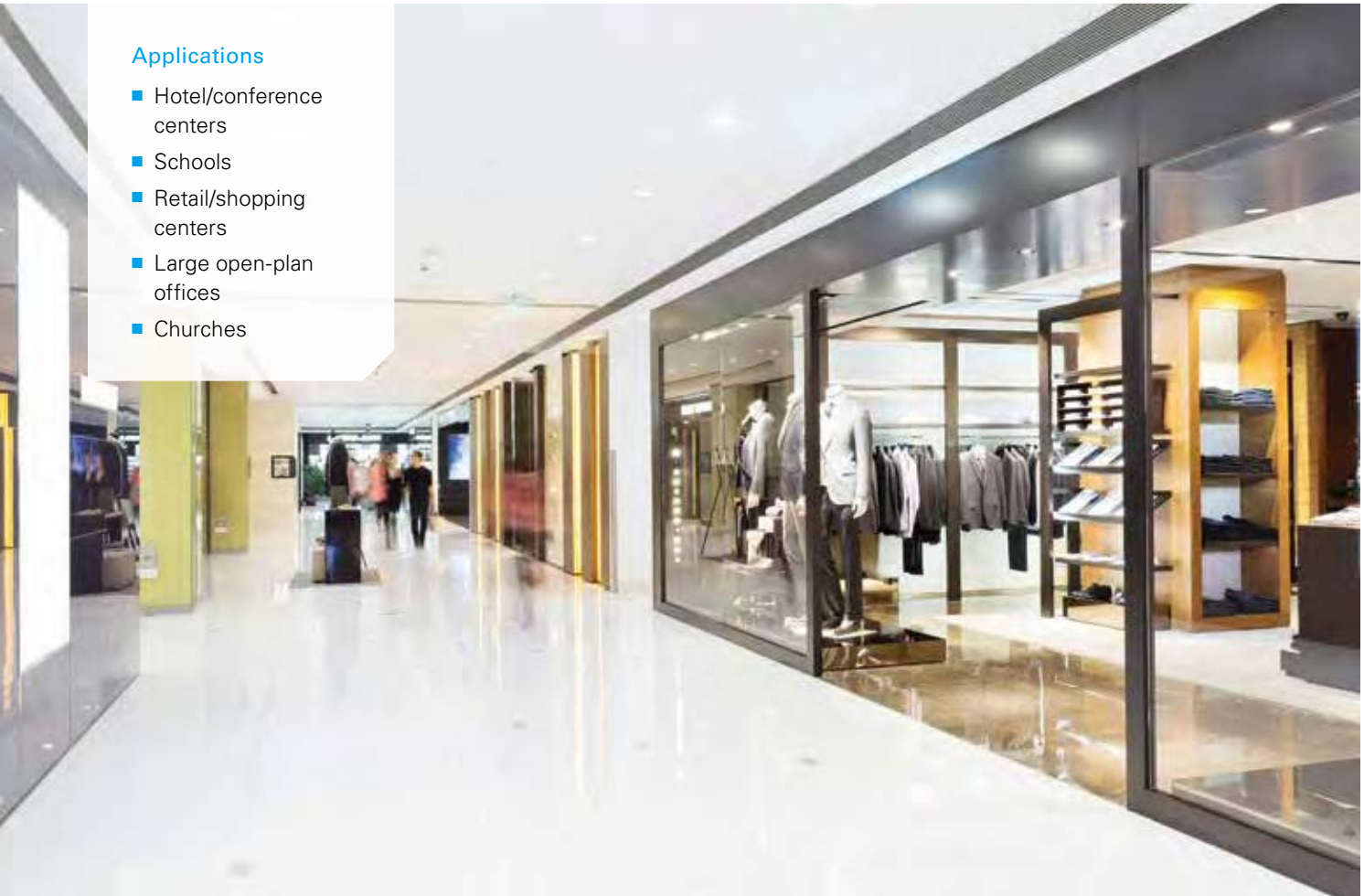

FXMQ-MVJU SPECIFICATIONS		6 TON	8 TON
Model Name		FXMQ72MVJU	FXMQ96MVJU
Power Supply	V/ph/Hz	208-230/1/60	
Rated Cooling Capacity	BTU/h	72,000	96,000
Rated Heating Capacity	BTU/h	81,000	108,000
Airflow Rate (H/L)	CFM	2,047/1,764	2,541/2,188
Weight	lbs	302	
Height	in.	18-1/8	
Width	in.	54-3/8	
Depth	in.	43-5/16	
Sound Pressure (H/L)	dB(A)	48/45	
Condensate Pipe Connection	in. O.D.	1	
Pipe Connections	Gas	3/4 (Flare)	7/8 (Flare)
	Liquid	3/8 (Flare)	
Refrigerant		R-410A	
Refrigerant Control		Electronic Expansion Valve	
Maximum Overcurrent Protective Device	A	15	
Minimum Circuit Amps	A	9.5	10.7
Protection Devices		Fuse and Fan Motor Thermal Protector	
External Finish		Galvanized Steel Plate	
External Static Pressure (Nominal/Maximum)	in. W.G.	0.38/0.95	0.43/1.1

Nominal Conditions:

Cooling Mode

Indoor: 80 °F DB / 67 °F WB
 Outdoor: 95 °F DB
 Pipe Length: 25 ft.
 Level Difference: 0 ft.

Heating Mode

Indoor: 70 °F DB
 Outdoor: 47 °F DB / 43 °F WB
 Pipe Length: 25 ft.
 Level Difference: 0 ft.

Note: Specifications are subject to change without notice.

FXMQ-MVJU ACCESSORIES

Model Name	FXMQ72MVJU	FXMQ96MVJU
Navigation Remote Controller*		BRC1E73
Simplified Wired Remote Controller*		BRC2A71
Wireless Remote Controller		BRC4C82
Remote Sensor Kit		KRCS01-1B
Wiring Adapter PCB (interface with aux/primary heater, humidifier, OA damper/fan)		KRP1C74
Group Control Adapter PCB (connects to external BMS)		KRP4A71
High Efficiency Filter Kit (MERV 13)		DACA-MQ96M-13-1K
High Efficiency Filter Kit (MERV 8)		DACA-MQ96M-8-1K

* Optional face plates available to provide a more intuitive user interface and disable specific functions

FXMQ-MVJU INSTALLATION SPACE

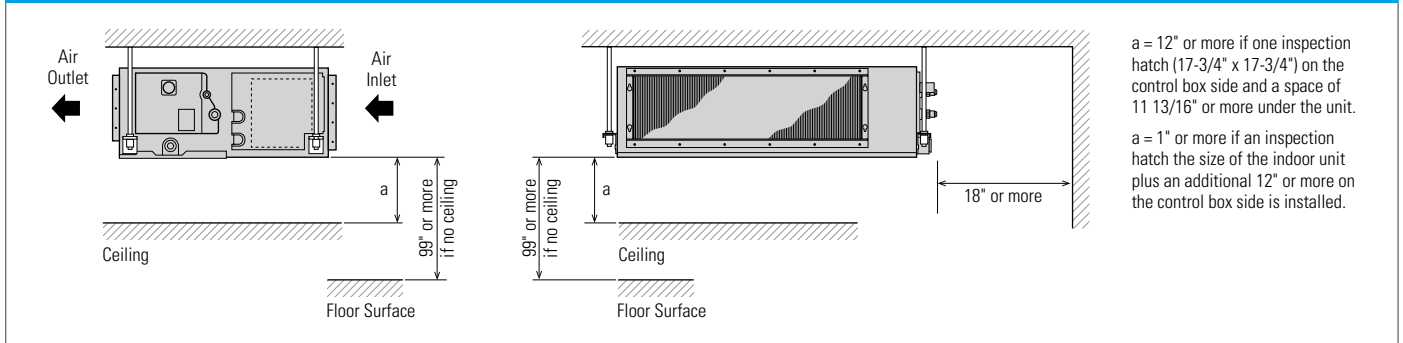

INDOOR UNITS

Concealed Floor-Standing Unit



Outside Air Integration Possible

Filter Included

Versatile, Logical, Durable, Quiet

The ideal way to save space, our floor-standing units can easily be installed along a perimeter wall — or concealed. The air distribution from these models will allow you to find the right balance for classrooms, churches, office hallways or similar spaces. The concealed floor units cover a wide range of capacities and can be built into counter in order to maintain the aesthetics of the room.

Features and Benefits

- Ideal for installation beneath a window
- Unit requires minimal installation space
- Fitted with a washable long-life filter
- Remote-control options available
- Space-saving unit can be freestanding or wall-mounted, concealed or exposed
- Models range from 7.5 MBH to 24 MBH



BRC1E73 (option)



BRC2A71 (option)



BRC4C82 (option)

Applications

- Multi-family residences
- Single-family residences
- Churches
- Historic buildings
- Schools
- Offices



FXNQ-MVJU9 SPECIFICATIONS			0.6 TON	0.75 TON	1 TON	1.5 TON	2 TON
Model Name			FXNQ07MVJU9	FXNQ09MVJU9	FXNQ12MVJU9	FXNQ18MVJU9	FXNQ24MVJU9
Power Supply	V/ph/Hz	208-230/1/60					
Rated Cooling Capacity	BTU/h	7,500	9,500	12,000	18,000	24,000	
Rated Heating Capacity	BTU/h	8,500	10,500	13,500	20,000	27,000	
Airflow Rate (H/L)	CFM	245/210		280/210	490/380	560/420	
Weight	lbs	47		51	60		
Height	in.	24					
Width	in.	36-5/8		42-1/8	53-1/8		
Depth	in.	8-5/8					
Sound Pressure (H/L)	dB(A)	35/32		36/33	40/35	41/36	
Condensate Pipe Connection	in. O.D.	27/32					
Pipe Connections	Gas	in.				1/2	
	Liquid	in.				1/4	
Refrigerant		R-410A					
Refrigerant Control		Electronic Expansion Valve					
Maximum Overcurrent Protective Device	A	15					
Minimum Circuit Amps	A	0.3		0.5	0.6		
Protection Devices		Fuse and Fan Motor Thermal Protector					
External Finish		Galvanized Steel Plate					
Standard Filter Type		Resin Net (with Mold Resistant)					

Nominal Conditions:

Cooling Mode
 Indoor: 80 °F DB / 67 °F WB
 Outdoor: 95 °F DB
 Pipe Length: 25 ft.
 Level Difference: 0 ft.

Heating Mode
 Indoor: 70 °F DB
 Outdoor: 47 °F DB / 43 °F WB
 Pipe Length: 25 ft.
 Level Difference: 0 ft.

Note: Specifications are subject to change without notice.

FXNQ-MVJU9 ACCESSORIES

Model Name	FXNQ07MVJU9	FXNQ09MVJU9	FXNQ12MVJU9	FXNQ18MVJU9	FXNQ24MVJU9
Navigation Remote Controller				BRC1E73	
Simplified Wired Remote Controller*				BRC2A71	
Wireless Remote Controller				BRC4C82	
Remote Sensor Kit				KRCS01-1B	
Wiring Adapter PCB (interface with aux/primary heater, humidifier, OA damper/fan)				KRP1C74	
Group Control Adapter PCB (connects to external BMS)				KRP4A71	
Condensate Pump				DACA-CP3-1	

* Optional face plates available to provide a more intuitive user interface and disable specific functions

FXNQ-MVJU9 INSTALLATION SPACE

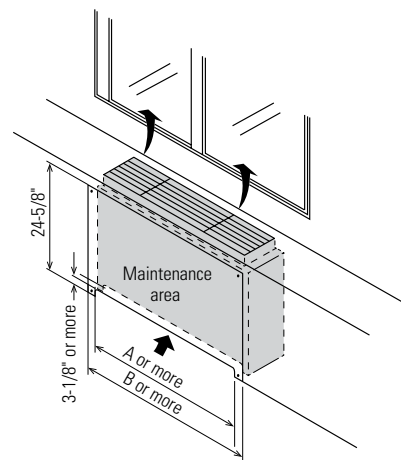
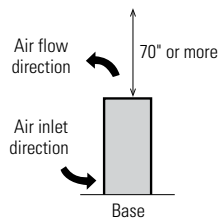
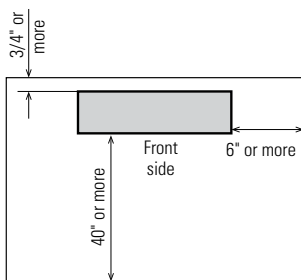

IMPORTANT
 Leave sufficient clearance for air inlet and maintenance.

MODEL	A (IN.)	B (IN.)
FXNQ12MVJU9	28	46
FXNQ18 - 24MVJU9	39	57
FXNQ07-09MVJU	23	41

Round Flow Sensing Cassette



Condensate Pump as Standard



Outside Air Integration Possible



Filter Included



Optional Auto Cleaning Filter



Surface & Occupancy Sensor Kit as Standard

Adaptive Comfort Control

The Round Flow Sensing Cassette is ideal for open plan applications such as classrooms and offices where adaptive comfort control is preferred. The unit provides an excellent comfort level, energy efficiency, and flexibility due to advanced control functions based on input from three room sensors (occupancy, air temperature, and surface temperature). With 18 configurable airflow distribution patterns, it can be efficient and provide a comfortable environment in smaller, more intricate spaces as well.

Features and Benefits

- Capacity range from 7.5 to 48 MBH.
- True 360° Airflow and three room sensors enables optimized occupant comfort and efficiency
- Energy efficient with DC fan motor and auto-logic that adjusts fan speed based on space load
- Optional self-cleaning air filter panel to further increase efficiency and reduce maintenance costs, when used in VRV IV systems
- Very flexible with 18 different possible airflow patterns, ensuring ideal air distribution to maximize comfort and efficiency
- Compact design to allow for installation in small ceiling voids
- Sound pressure levels as low as 27 db(A)
- Enhanced indoor air quality and LEED ready with MERV 13 filter options

The built-in occupancy sensor has two main functions: save energy and optimize occupancy comfort. In order to save energy, the function of the occupancy sensor can be used to automatically set back the air temperature and also lower the fan speed if no people are present in the room.



Together with the occupancy sensor, the air-temperature sensor and the built-in surface temperature sensor are used to maintain an even and comfortable temperature distribution from floor to ceiling in the room. This is done by automatically adjusting the supplied airflow rate and the individual position of each of the four supply air louvers in the unit, thus maintaining the required comfortable space environment.

In order to further increase efficiency and reduce maintenance costs, the Round-Flow Sensing Cassette can be equipped with an optional self-cleaning filter panel that performs automatic air-filter cleaning up to once a day. Dust is deposited into a collection box during the self-cleaning process. When indicated with light on the unit and on the controller display, the dust collection box in the unit can easily and quickly be emptied with a standard vacuum cleaner.

4-way flow vs. Round Flow

Round Flow Ceiling Mounted Cassette type offers 360° airflow with improved temperature distribution.

4-way flow

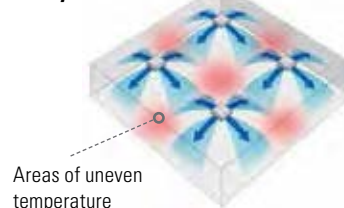

Areas of uneven temperature

Round Flow

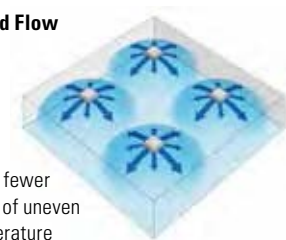

Much fewer areas of uneven temperature

Applications

- Retail
- Schools
- Offices
- Restaurants



Advanced design for comfort and efficiency

Heat Exchanger Design

Optimized for part load operation — great enhancement to seasonal energy efficiency

Occupancy and Surface Temperature Sensors

Enables additional energy savings and increased comfort

Optional Self-Cleaning Filter Panel

Provides optimum efficiency, airflow and reduced maintenance



DC Fan Motor

Very efficient — enables fan auto logic based on ΔT set point

DC Drain Pump

Low power consumption

Decoration Panel

- Efficient due to large air discharge outlets
- Unique 360° airflow distribution
- 4 individually controlled louvers enables optimized comfort in the space
- Possibility to close 1, 2 or 3 louvers adds flexibility

Automatic air-direction control



Air flow from the indoor unit is automatically adjusted to always maintain a comfortable environment — even when occupancy changes.

Dual infrared sensors

Sensors detect the presence of people and surface temperature to provide comfortable air-conditioning and energy savings.

Infrared presence sensor

The sensor detects human presence, and energy saving control can be performed when no people are detected.

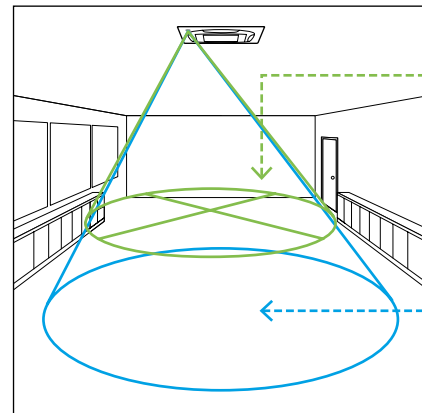

Infrared surface sensor

The sensor detects the surface temperature and automatically adjusts operation of the indoor unit to reduce the temperature difference between the ceiling and the floor.

Round Flow Sensing Cassette



Condensate Pump as Standard



Outside Air Integration Possible



Filter Included



Optional Auto Cleaning Filter



Surface & Occupancy Sensor Kit as Standard

Automatic air filter cleaning (optional)

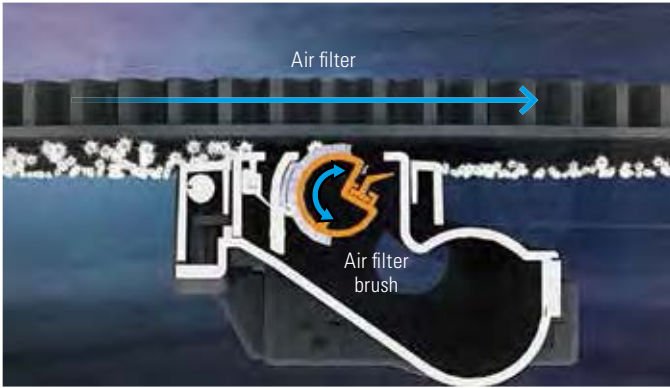

At the programmed time, the air filter rotates while the air filter brush turns back and forth to brush the filter.

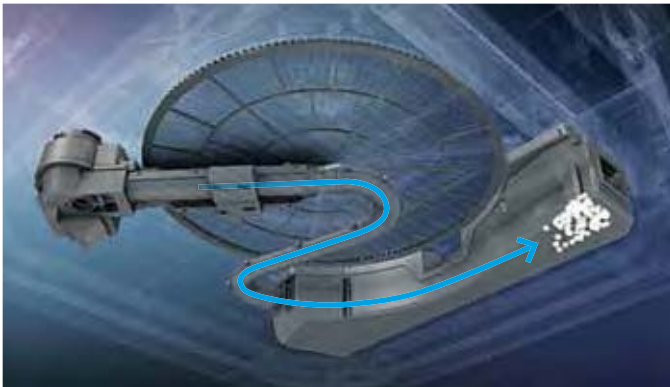

Dust from the air filter brush is deposited into the dust collection container during the fully automatic self-cleaning process.

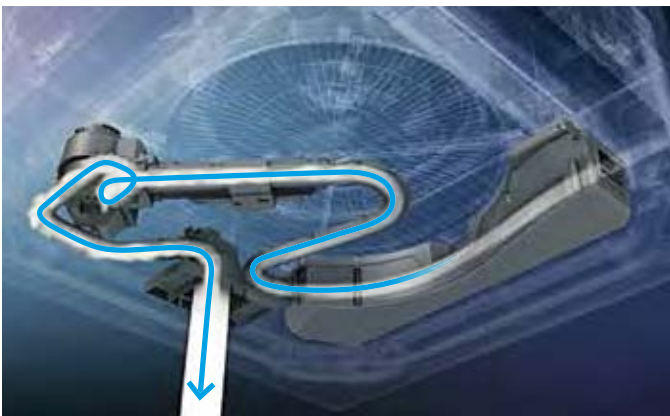

When indicated, the dust container in the unit is easily emptied with a standard vacuum cleaner.



FXFQ-TVJU SPECIFICATIONS		0.60 TON	0.75 TON	1 TON	1.25 TON	1.5 TON	2 TON	2.5 TON	3 TON	4 TON
Model Name		FXFQ07TVJU	FXFQ09TVJU	FXFQ12TVJU	FXFQ15TVJU	FXFQ18TVJU	FXFQ24TVJU	FXFQ30TVJU	FXFQ36TVJU	FXFQ48TVJU
Power Supply	(V/ph/Hz)	208-230/1/60								
Rated Cooling Capacity	BTU/h	7,500	9,500	12,000	15,000	18,000	24,000	30,000	36,000	48,000
Rated Heating Capacity	BTU/h	8,500	10,500	13,500	17,000	20,000	27,000	34,000	40,000	54,000
Airflow Rate (H/M/L)	CFM	420/406/353	441/406/353	441/406/353	512/459/388	742/618/477	777/618/477	1,112/918/671	1,165/918/671	1,218/971/742
Weight	lbs	42			48			58		
Height	in.	9-11/16						11-5/16		
Width	in.	33-1/16								
Depth	in.	33-1/16								
Sound Pressure (H/M/L)	dB(A)	30/28.5/27			31/29/27	35.5/32/28	36/32/28	43.5/38/32	44/38/32	45/40/35
Condensate Pump Lift	in.	33-1/2								
Condensate Pipe Connection	in. O.D.	1-1/4								
Pipe Connections	Gas	in.			1/2 (Flare)			5/8 (Flare)		
	Liquid	in.			1/4 (Flare)			3/8 (Flare)		
Refrigerant		R-410A								
Refrigerant Control		Electronic Expansion Valve								
Maximum Overcurrent Protective Device	A	15								
Minimum Circuit Amps	A	0.3			0.4	0.6	0.7	1.3	1.5	1.8
Protection Devices		Fuse/Breaker and Fan Motor Thermal Protector								
External Finish		Galvanized Steel Plate								
Standard Filter Type		Mold-Resistant Resin Net								

Nominal Conditions:

Cooling Mode

Indoor: 80 °F DB / 67 °F WB
 Outdoor: 95 °F DB
 Pipe Length: 25 ft.
 Level Difference: 0 ft.

Heating Mode

Indoor: 70 °F DB
 Outdoor: 47 °F DB / 43 °F WB
 Pipe Length: 25 ft.
 Level Difference: 0 ft.

Note: Specifications are subject to change without notice.

OPTION	FXFQ09-48TVJU			
Type of panel	Self-Cleaning Filter Panel		Standard Sensing Decoration Panel	
Self-Cleaning Filter Panel	BYCQ125BGW1		-	
Connection pipe (for dust recovery)	KKHAP55B160		-	
L-shape extension pipe	KKHAP55A160		-	
Standard Sensing Decoration Panel	-		BYCQ125B-W1	
Sealing material for air discharge outlet	KDBH55K160F		KDBHQ55B140	
Panel spacer	KDBP55H160FA		KDBP55H160FA	
Fresh air intake kit	Chamber type	Without T shape pipe	-	
		With T shape pipe	KDDP55B160K	
	Direct installation type	KDDP55X160		
Filter chamber	-		KDDFP55B160	
Replacement long life filter	-		KAFP55B160	
Replacement ultra long life filter	-		KAFP55H160H	
Self-Cleaning Filter Panel replacement filter	KAFP55A160			
Branch duct chamber	KDJP55B80	KDJP55B160	KDJP55B80	KDJP55B160
	-		DACA-FQP13-1K	
MERV 13 Filter Kit	-			

OUTDOOR / CONDENSING UNIT COMPATIBILITY		
Outdoor Condensing Unit	FXFQ-TVJU with:	
	Self-Cleaning Filter Panel (BYCQ125BGW1)	Standard Sensing Decoration Panel (BYCQ125B-W1)
VRV IV	Yes	
VRV III, VRV IV W-Series, VRV III-S	No	Yes
SkyAir	No	

FXFQ-TVJU INSTALLATION SPACE

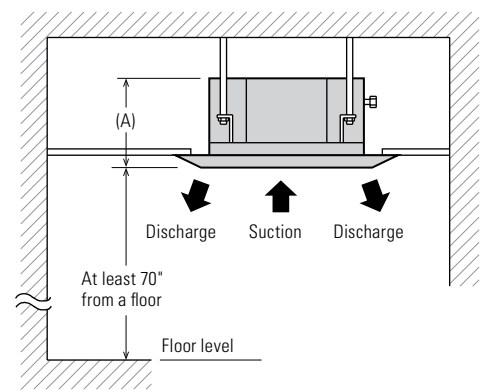
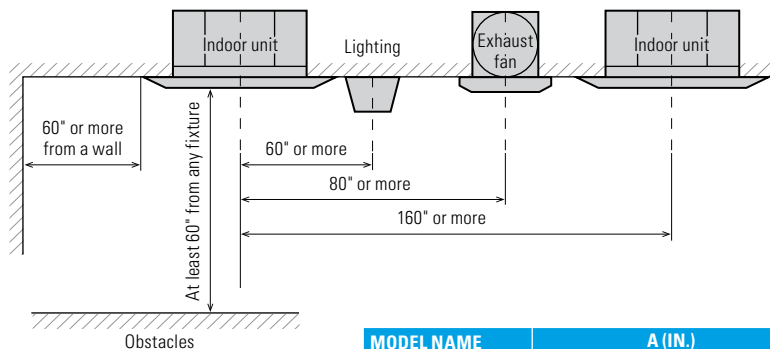

4-Way Ceiling-Suspended Cassette



Condensate Pump
as Standard



Filter
Included



Optional Surface &
Occupancy Sensor Kit

Slim, Stylish, Flexible

The unique 4-way ceiling-suspended cassette is an ideal solution for rooms without a false ceiling, or minimal space above a false ceiling, where adaptive comfort control is preferred.

The optional Sensor Kit (occupancy and surface temperature) together with air temperature sensor and advanced control functions enables the unit to provide an exceptional comfort level, energy efficiency, and flexibility.

Features and Benefits

- Very low unit height of under 8" makes it an ideal solution for school, shops, restaurants and offices with no or low false ceilings
- Optional Sensor Kit enables input from three room sensors to provide optimized occupant comfort and efficiency
- Stylish unit blends easily with any interior, as the air louvers close entirely when not in operation
- Energy efficient fan motor
- Individual air louver control — one or more louvers can be easily closed via the remote controller when required
- Ideal for both new and existing buildings
- Can also be mounted partially recessed in a false ceiling
- Same appearance and size for all capacity models
- Standard drain pump with 19.5" lift



BRC1E73 (option)



BRC2A71 (option)

Flexible Airflow Pattern

The four individually controlled air louvers in the unit enables comfortable space environment in a variety of different room layouts.

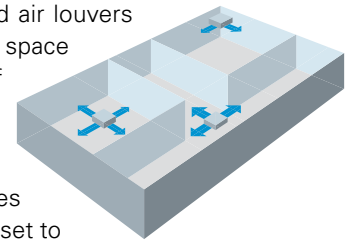

Air from each louver can be set to exhaust in 5 different angles between 0 and 60 degrees, or set to auto-swing.

Airflow Angles

Auto Swing: Wide discharge angle: 0° to 60°

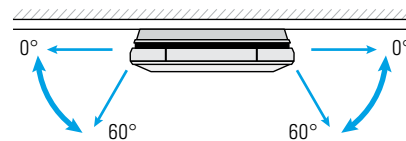

Fixed angles: 5 levels

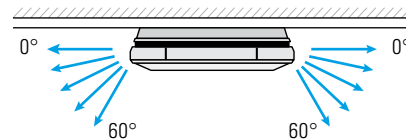

Applications

- Retail
- Schools
- Offices
- Restaurants

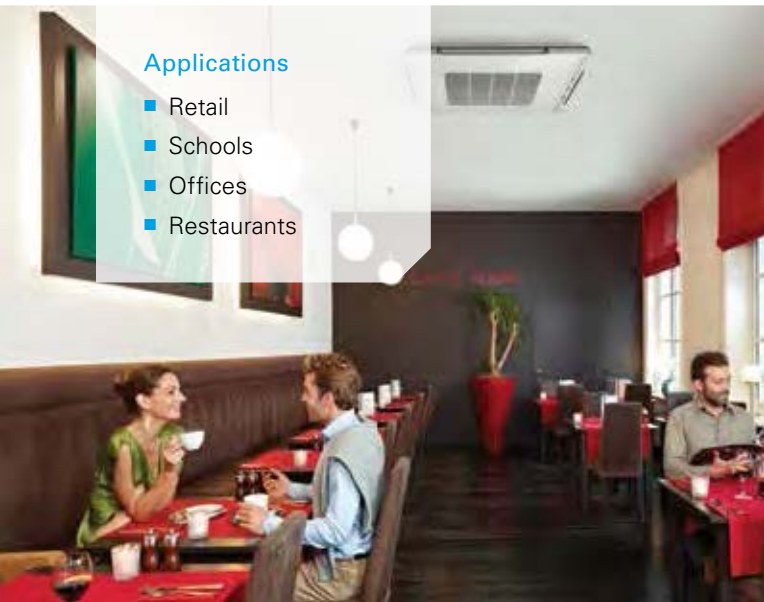

FXUQ-PVJU SPECIFICATIONS		1.5 TON	2 TON	2.5 TON	3 TON
Model Name		FXUQ18PVJU	FXUQ24PVJU	FXUQ30PVJU	FXUQ36PVJU
Power Supply	(V/ph/Hz)	208-230/1/60			
Rated Cooling Capacity	BTU/h	18,000	24,000	30,000	36,000
Rated Heating Capacity	BTU/h	20,000	27,000	34,000	40,000
Airflow Rate (H/M/L)	CFM	795/689/565		1095/918/742	
Weight	lbs	58			60
Height	in.	7-13/16			
Width	in.	37 3/8			
Depth	in.	37 3/8			
Sound Pressure (H/M/L)	dB(A)	40/38/36		47/44/40	
Condensate Pump Lift	in.	19.5			
Condensate Pipe Connection	in. O.D.	VP20			
Pipe Connections	Gas	in.	1/4 (Flare)	3/8 (Flare)	
	Liquid	in.	1/2 (Flare)	5/8 (Flare)	
Refrigerant		R-410A			
Refrigerant Control		Electronic Expansion Valve			
Maximum Overcurrent Protective Device	A	15			
Minimum Circuit Amps	A	0.6		1.4	
Protection Devices		Fuse and Fan Motor Thermal Protector			
External Finish		White Casing			
Standard Filter Type		Resin Net (with Mold Resister)			

Nominal Conditions:

Cooling Mode
 Indoor: 80 °F DB / 67 °F WB
 Outdoor: 95 °F DB
 Pipe Length: 25 ft.
 Level Difference: 0 ft.

Heating Mode
 Indoor: 70 °F DB
 Outdoor: 47 °F DB / 43 °F WB
 Pipe Length: 25 ft.
 Level Difference: 0 ft.

Note: Specifications are subject to change without notice.

FXUQ-PVJU ACCESSORIES				
Model Name	FXUQ18PVJU	FXUQ24PVJU	FXUQ30PVJU	FXUQ36PVJU
Sealing Member of Air Discharge Outlet			KDBHP49B140	
Decoration Panel for Air Discharge			KDBTP49B140	
Replacement Long-Life Filter			KAFP551K160	
Remote Control (wired type)			BRC1E73	
Sensor Kit ²			BRE49B1F	
Group Control Adapter Printed Circuit Board ¹			KRP4A74	
Installation Box for Adapter PCB			KRP1BA97	
Remote Sensor ²			KRCS01-48	

¹ Installation box for Adapter PCB (KRP1BA97) is necessary. ² Remote Sensor can only be installed when Sensor Kit is not installed.

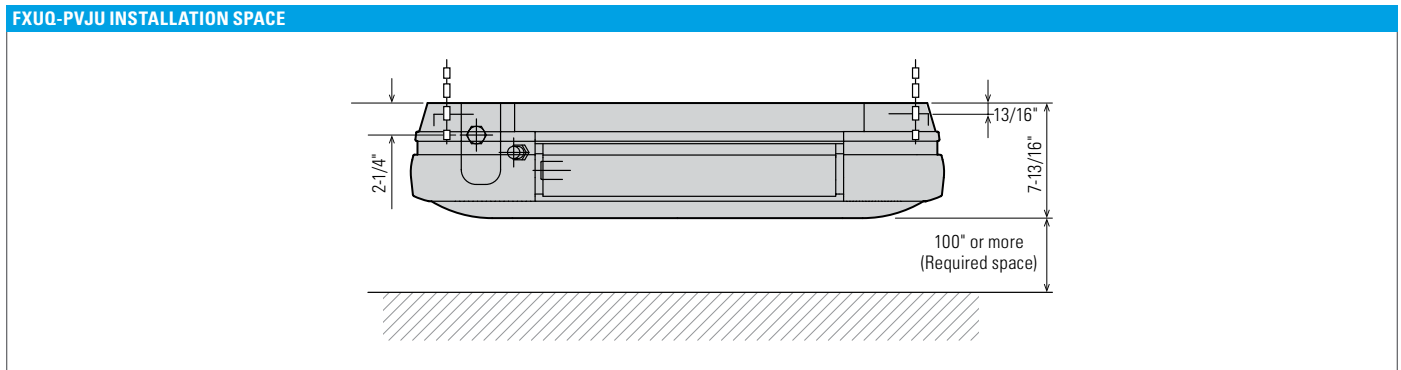

Automatic air-direction control



Air-flow from the indoor unit is automatically adjusted to always maintain a comfortable environment — even when occupancy changes.

FXZQ-MVJU9

2'x2' 4-Way Ceiling-Mounted Cassette



Condensate Pump as Standard



Outside Air Integration Possible



Filter Included

Elegant, Low-maintenance, Comfortable

The 2'x2' 4-way Cassette is ideal for open plan applications such as classrooms, offices and retail. It provides both low noise and customizable comfort. Air can be distributed in any of four directions and the 2'x2' size of the unit makes layout and installation very easy.

Features and Benefits

- Fits in a standard 2'x2' ceiling grid.
- Sound pressure levels are as low as 29 dB(A)
- Space-saving depth of units requires only 11.6" of ceiling space
- Three auto-swing positions to choose from — standard, draft prevention and ceiling stain prevention
- Simple installation with an easy-to-fit decoration panel, easy height adjustment and a suction grille that can rotate up to 90°
- Easy-to-clean grille, washable long-life filter
- Condensate pump inside the unit with up to 21-1/2" lift as standard
- Models range from 7.5 MBH to 18 MBH



BRC1E73 (option)



BRC2A71 (option)



BRC7E830 (option)

Flexible Airflow Patterns

The four air louvers in the unit enables comfortable space environment in many different room layouts.

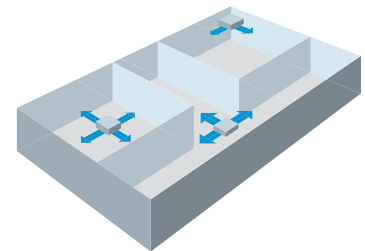

Applications

- Retail
- Schools
- Offices



Airflow Angles

Auto Swing: Wide discharge angle: 0° to 60°

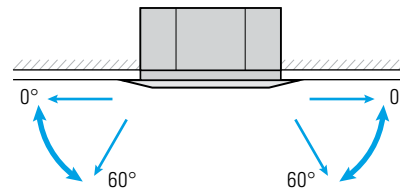

Fixed Angles: 5 Levels

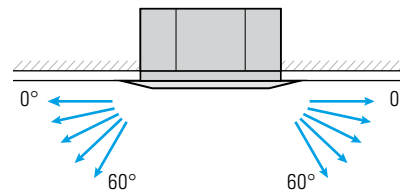

Angles can be also set on site to prevent drafts (0°-35°) or soiling of the ceiling (25°-60°), other than standard setting (0°-60°).

FXZQ-MVJU9 SPECIFICATIONS		0.6 TON	0.75 TON	1 TON	1.25 TON	1.5 TON	
Model Name		FXZQ07MVJU9	FXZQ09MVJU9	FXZQ12MVJU9	FXZQ15MVJU9	FXZQ18MVJU9	
Power Supply		V/ph/Hz					
Rated Cooling Capacity		7,500	9,500	12,000	15,000	18,000	
Rated Heating Capacity		8,700	11,100	14,000	17,500	21,000	
Airflow Rate (H/L)		320/247	335/265	335/265	388/282	495/353	
Weight		lbs					
Height		in.					
Width		in.					
Depth		in.					
Sound Pressure (H/L)		31/29	33/29	41/34			
Condensate Pump Lift		in.					
Condensate Pipe Connection		in. O.D.					
Pipe Connections	Gas	in.				1/2 (Flare)	
	Liquid	in.				1/4 (Flare)	
Refrigerant		R-410A					
Refrigerant Control		Electronic Expansion Valve					
Maximum Overcurrent Protective Device		A				15	
Minimum Circuit Amps		A				0.8	0.9
Protection Devices		Fuse and Fan Motor Thermal Protector					
External Finish		Galvanized Steel Plate					
Standard Filter Type		Resin Net (with Mold Resistant)					

Nominal Conditions:

Cooling Mode

Indoor: 80 °F DB / 67 °F WB
 Outdoor: 95 °F DB
 Pipe Length: 25 ft.
 Level Difference: 0 ft.

Heating Mode

Indoor: 70 °F DB
 Outdoor: 47 °F DB / 43 °F WB
 Pipe Length: 25 ft.
 Level Difference: 0 ft.

Note: Specifications are subject to change without notice.

FXZQ-MVJU9 ACCESSORIES

Model Name	FXZQ07MVJU9	FXZQ09MVJU9	FXZQ12MVJU9	FXZQ18MVJU9
Navigation Remote Controller*			BRC1E73	
Simplified Wired Remote Controller*			BRC2A71	
Remote Sensor Kit			KRCS01-1B	
Decoration Panel			BYFQ60B8W1U	
Wiring Adapter PCB (interface with aux/primary heater, humidifier, OA damper/fan)			KRP1B72	
Long-Life Replacement Filter			KAFQ441BA60	
Sealing Member of Air Discharge Outlet			KDBHQ44B60	
Panel Spacer			KDBQ44B60	
Fresh Air Intake Kit			KDDQ44XA60	

* Optional face plates available to provide a more intuitive user interface and disable specific functions

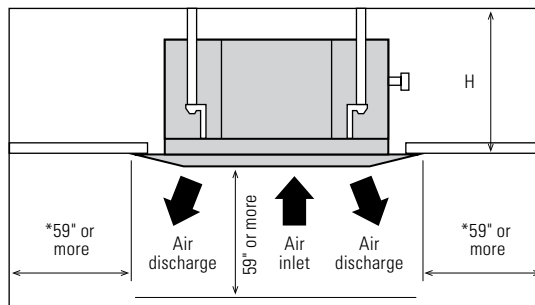

FXZQ-MVJU9 INSTALLATION SPACE



MODEL	HEIGHT
FXZQ07-18MVJU9	11.6" or more

* Leave 7-7/8" or more space on sides where the air outlet is closed.

Ceiling-Mounted Cassette (Single Flow)

-  Condensate Pump as Standard
-  Outside Air Integration Possible
-  Filter Included

Slim and Compact Design for Installation Flexibility

Features and Benefits

- The main body of the unit is optimized to be a compact design. Only 7-³/₈" in height and a width of 18-¹/₂" making it possible to use this style of indoor unit in the tightest of spaces.

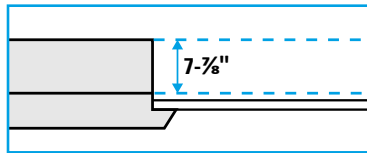

- The innovative discharge air louver design forces air in heating mode to ground level to improve the overall space heating effect of the indoor unit.

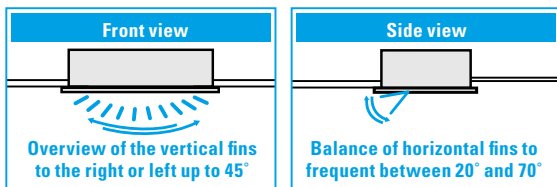

- The unit is equipped with both horizontal and vertical louvers that can be freely adjusted with the remote controller providing a capability to optimize the airflow and throw to suit your room design.
- The utilization of both a DC-style Fan Motor and integrated Condensate Pump allow for improvements in energy consumption as well as lower operating sound levels than other styles of indoor units.
- This Indoor unit can be set to 5 predetermined fan speeds using the BRC1E73 wired remote controller, which allows for optimum and comfortable airflow.



- A Ventilation Air knock-out is provided to allow up to 15% of the rated airflow through the unit to be pretreated outside air.
- The innovative "smooth finish" decoration panel design helps to minimize dust and dirt build-up and facilitates easier cleaning.



- The Indoor Unit is equipped with a factory installed condensate pump with a lift capacity of up to 33-7/16" (measured from the bottom of the unit).

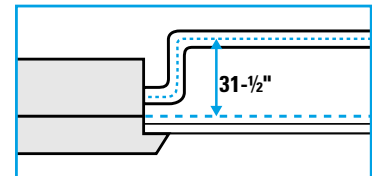

- The units are equipped with customizable auxiliary heat control settings to facilitate the On/Off control of an external auxiliary heat solution.
- For ease of service and maintenance activities, it is possible to access the main components of the unit by only removing the decoration panel.

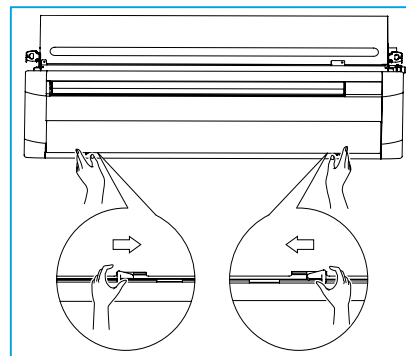

INDOOR UNITS

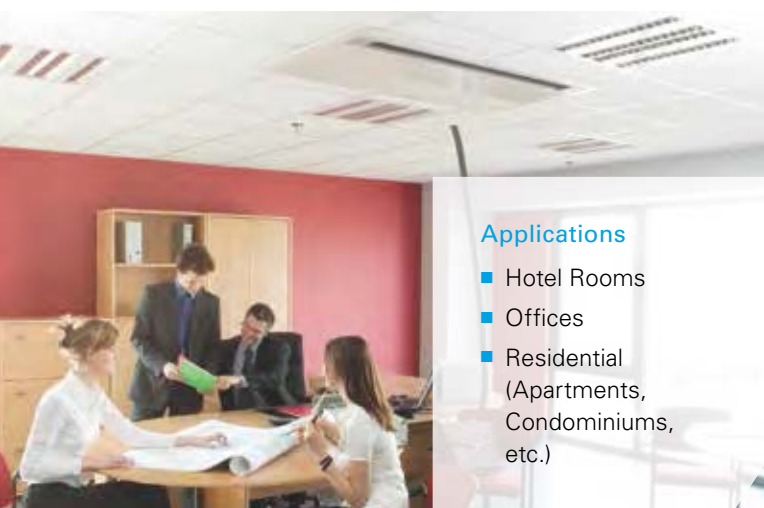

Applications

- Hotel Rooms
- Offices
- Residential (Apartments, Condominiums, etc.)

FXEQ-PVJU SPECIFICATIONS				0.6 TON	0.75 TON	1.0 TON	1.25 TON	1.5 TON	2 TON	
MODEL				FXEQ07PVJU	FXEQ09PVJU	FXEQ12PVJU	FXEQ15PVJU	FXEQ18PVJU	FXEQ24PVJU	
Power Supply				1 phase 60Hz 208/230V						
Cooling capacity	*1,*3	Btu/h (kW)	7500 (2.5)	9500 (2.8)	12000 (3.5)	15000 (4.4)	18000 (5.3)	24000 (7.0)		
Heating capacity	*2,*3	Btu/h (kW)	8500 (2.5)	10500 (3.1)	13500 (4.0)	17000 (5.0)	20000 (5.9)	27000 (7.9)		
Electrical	Min. circuit amps (MCA)	A	0.3	0.4	0.4	0.5	0.5	0.7		
	Max. overcurrent protection (MOP)	A	15	15	15	15	15	15		
Casing/color				Galvanized steel plate						
Dimensions: (H x W x D)				7- ⁷ / ₈ x 18- ¹ / ₂ x 33-1- ¹ / ₁₆ (200 x 470 x 840)				7- ⁷ / ₈ x 18- ¹ / ₂ x 48-13- ¹ / ₁₆ (200 x 470 x 1240)		
Fan	Type			Sirocco fan						
	Air flow rate (Dry coil)	Cooling (H/HM/M/ML/L)	CFM (m ³ /min)	212/191/173/155/141 (6.0/5.4/4.9/4.4/4.0)	244/226/205/187/170 (6.9/6.4/5.8/5.3/4.8)	283/265/247/223/194 (8.0/7.5/7.0/6.3/5.5)	346/311/276/247/219 (9.8/8.8/7.8/7.0/6.2)	441/403/367/336/307 (12.5/11.4/10.4/9.5/8.7)	530/481/431/389/346 (15.0/13.6/12.2/11.0/9.8)	
	Drive			Direct drive						
Sound pressure level	Cooling (H/HM/M/ML/L)	dBA	30/29/28/27/26	32/31/30/29/28	35/34/33/32/30	38/37/35/33/31	38/37/35/33/31	43/41/39/37/35		
Weight				37.5 (17)		39.7 (18)		50.7 (23)		
Piping connections	Liquid	in. (mm)	ø 1/4 (6.4) (flare connection)					ø 3/8 (9.5) (flare connection)		
	Gas	in. (mm)	ø 1/2 (12.7) (flare connection)					ø 3/4 (15.9) (flare connection)		
	Drain	in. (mm)	PVC26 (O.D. 1-1/32 (26) x I.D. 13/16 (20))						25 (635)	
Drain pump lift				25 (635)						
Refrigerant control				Electronic expansion valve						
Connectable outdoor unit				R-410A VRV Series						
Decoration panel (required option)	Model			BYEP40AW1			BYEP63AW1			
	Color			Fresh White						
	Dimensions (H x W x D)			3-3/16 x 21- ⁵ / ₈ x 37-13/32 (80 x 550 x 950)				3-3/16 x 21- ⁵ / ₈ x 53-5/32 (80 x 550 x 1350)		
	Air filter			Resin net (with mold resistant)						
	Weight			17.6 (8)		22 (10)				

Note: *1. Nominal cooling capacities are based on the following conditions: return air temperature: 80.0° FDB (26.7° C DB), 67.0° FWB (19.4° CWB), outdoor temperature: 95.0° FDB (35° C DB) equivalent ref. piping: 25ft. (7.6m) (Horizontal)
 *2. Nominal heating capacities are based on the following conditions: return air temperature: 70.0° FDB (21.1° C DB), outdoor temperature: 47.0° FDB (8.3° C DB), 43.0° FDB (6.1° C WB) equivalent ref. piping: 25ft. (7.6m) (Horizontal)
 *3. Capacities are net, including a deduction for cooling (an addition for heating) for indoor fan motor heat.

FXEQ-PVJU ACCESSORIES				FXEQ07PVJU	FXEQ09PVJU	FXEQ12PVJU	FXEQ15PVJU	FXEQ18PVJU	FXEQ24PVJU
No.	Name of Option	Note							
1	Decoration panel		BYEP40AW1				BYEP63AW1		
2	Wired remote controller		BRC1E73						
3	Simplified remote controller		BRC2A71						
4	Remote sensor		KRCS01-4B						
5	Central remote controller		DCS302C71						
5-1	Electrical box	1	KJB311AA						
6	Unified on/off controller		DCS301C71						
6-1	Electrical box	1	KJB212AA						
7	Schedule timer		DST301BA61						
8	intelligent Touch controller		DCS601C71						
9	DIII-NET expander adaptor		DTA109A51						
10	Wiring adaptor printed circuit board	2	KRP1C75						
11	Group control adaptor printed circuit board	2	KRP4A74						
12	Adaptor mounting box		KRP1B101						

Note: *1. Electrical box (No.5-1/6-1) is required for controller (No. 5/6) *2. Adaptor mounting box (No.12) is necessary.

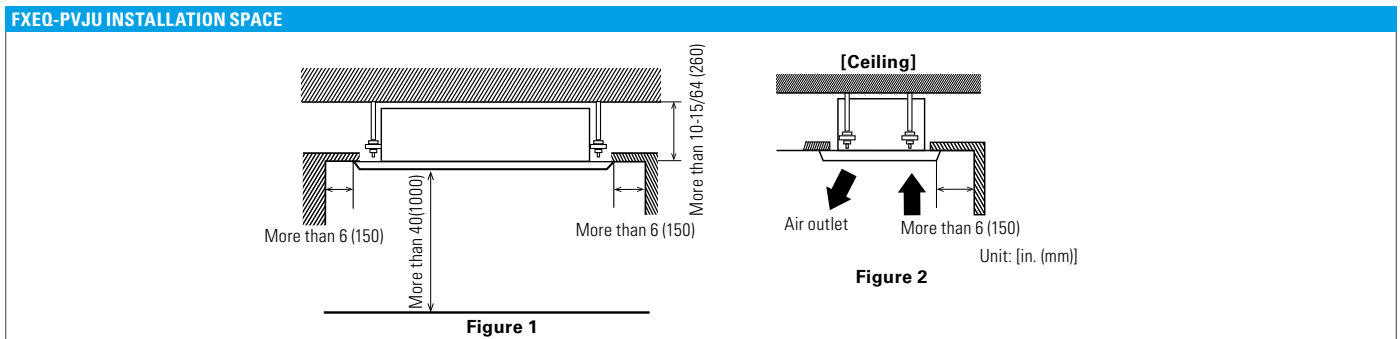

Ceiling-Suspended Unit



Optional
Condensate Pump



Filter
Included

Slim, Efficient, Quiet, Easy to Maintain

With its slim, elegant design, the FXHQ ceiling-suspended unit is a great fit for any light commercial space. Wide air openings provide a comfortable airflow and an innovative stream fan ensures quiet operation, making it ideal for retail stores, restaurants, classrooms and conference rooms.

Features and Benefits

- One of our slimmest indoor units (less than 8") fits within any interior design
- Wide air discharge outlet distributes a comfortable airflow throughout the entire space with throw of up to 25 ft.
- Innovative stream fan technology keeps sound pressure levels low
- Smooth flat louver design makes cleaning simple
- Long-life filter is standard
- Models range from 12 MBH to 36 MBH



BRC1E73 (option)



BRC2A71 (option)



BRC7E83 (option)

Quiet Stream Fan (side view)

Uses the quiet stream fan and many more advanced technologies.

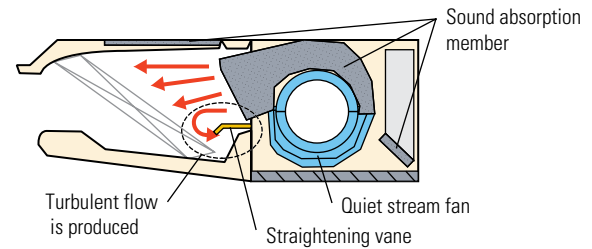

Applications

- Retail/shops
- Offices
- Restaurants



FXHQ-MVJU SPECIFICATIONS		1 TON	2 TON	3 TON
Model Name		FXHQ12MVJU	FXHQ24MVJU	FXHQ36MVJU
Power Supply	V/ph/Hz	208-230/1/60		
Rated Cooling Capacity	BTU/h	12,000	24,000	36,000
Rated Heating Capacity	BTU/h	13,500	27,000	40,000
Airflow Rate (H/L)	CFM	410/340	710/600	830/670
Weight	lbs	55	80	90
Height	in.	7-11/16		
Width	in.	37-13/16	55-1/8	62-5/8
Depth	in.	26-3/4		
Sound Pressure (H/L)	dB(A)	42/33	44/36	46/41
Condensate Pipe Connection	in. O.D.	1		
Pipe Connections	Gas	1/2 (Flare)	5/8 (Flare)	
	Liquid	1/4 (Flare)	3/8 (Flare)	
Refrigerant		R-410A		
Refrigerant Control		Electronic Expansion Valve		
Maximum Overcurrent Protective Device	A	15		
Minimum Circuit Amps	A	0.8	1.0	1.4
Protection Devices		Fuse and Fan Motor Thermal Protector		
External Finish		White Casing		
Standard Filter Type		Resin Net (with Mold Resistant)		

Nominal Conditions:

Cooling Mode

Indoor: 80 °F DB / 67 °F WB
 Outdoor: 95 °F DB
 Pipe Length: 25 ft.
 Level Difference: 0 ft.

Heating Mode

Indoor: 70 °F DB
 Outdoor: 47 °F DB / 43 °F WB
 Pipe Length: 25 ft.
 Level Difference: 0 ft.

Note: Specifications are subject to change without notice.

FXHQ-MVJU ACCESSORIES			
Model Name	FXHQ12MVJU	FXHQ24MVJU	FXHQ36MVJU
Navigation Remote Controller*		BRC1E73	
Simplified Wired Remote Controller*		BRC2A71	
Wireless Remote Controller		BRC7E83	
Remote Sensor Kit		KRCS01-1B	
Wiring Adapter PCB (interface with aux/primary heater, humidifier, OA damper/fan)		KRP1C74	
Group Control Adapter PCB (connects to external BMS)		KRP4A72	
Replacement long-life filter	KAFJ501D56	KAFJ501D112	KAFJ501D160
Condensate Pump		DACA-CP3-1	

* Optional face plates available to provide a more intuitive user interface and disable specific functions

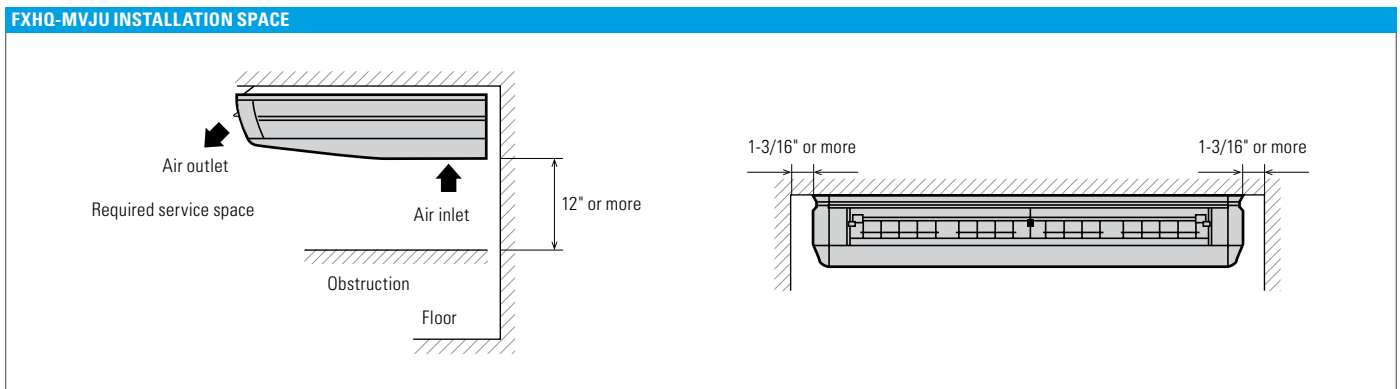

INDOOR UNITS

Wall-Mounted Unit



Optional
Condensate Pump



Filter
Included

Stylish, Compact, Convenient, Comfortable

Daikin's wall-mounted units are ideal for cooling or heating smaller zones such as stores, offices, and restaurants. The compact, stylish design lets the unit blend discreetly into any interior design, and airflow can be supplied in any of five different directions and easily programmed via remote control.



Features and Benefits

- Auto-swing mechanism ensures efficient air distribution via louvers that automatically close when the unit is turned off
- Wide air discharge outlet distributes a comfortable airflow throughout the entire space
- Horizontal louvers and front panel can be easily removed for cleaning
- Drain pipe can be easily hidden from sight
- Models range from 7.5 MBH to 24 MBH



BRC1E73 (option)



BRC2A71 (option)



BRC7E818 (option)

Applications

- Retail
- Restaurants
- Offices
- Hotels
- Multi-family residences



FXAQ-PVJU SPECIFICATIONS			0.6 TON	0.75 TON	1 TON	1.5 TON	2 TON
Model Name			FXAQ07PVJU	FXAQ09PVJU	FXAQ12PVJU	FXAQ18PVJU	FXAQ24PVJU
Power Supply	V/ph/Hz		208-230/1/60				
Rated Cooling Capacity	BTU/h		7,500	9,500	12,000	18,000	24,000
Rated Heating Capacity	BTU/h		8,500	10,500	13,500	20,000	27,000
Airflow Rate (H/L)	CFM		260/160	280/175	300/180	500/400	635/470
Weight	lbs		25				
Height	in.		11-3/8				
Width	in.		31-1/4			41-3/8	
Depth	in.		9				
Sound Pressure (H/L)	dB(A)		36/31	37/31	38/31	43/37	47/40
Condensate Pipe Connection	in. O.D.		1 1/16				
Pipe Connections	Gas	in.	1/2 (Flare)				5/8 (Flare)
	Liquid	in.	1/4 (Flare)				3/8 (Flare)
Refrigerant			R-410A				
Refrigerant Control			Electronic Expansion Valve				
Maximum Overcurrent Protective Device	A		15				
Minimum Circuit Amps	A		0.4		0.5		0.6
Protection Devices			Fuse and Fan Motor Thermal Protector				
External Finish			White Casing				
Standard Filter Type			Resin Net (washable)				

Nominal Conditions:

Cooling Mode

Indoor: 80 °F DB / 67 °F WB
 Outdoor: 95 °F DB
 Pipe Length: 25 ft.
 Level Difference: 0 ft.

Heating Mode

Indoor: 70 °F DB
 Outdoor: 47 °F DB / 43 °F WB
 Pipe Length: 25 ft.
 Level Difference: 0 ft.

Note: Specifications are subject to change without notice.

FXAQ-PVJU ACCESSORIES					
Model Name	FXAQ07PVJU	FXAQ09PVJU	FXAQ12PVJU	FXAQ18PVJU	FXAQ24PVJU
Navigation Remote Controller*			BRC1E73		
Simplified Wired Remote Controller*			BRC2A71		
Wireless Remote Controller			BRC7E818		
Remote Sensor Kit			KRCS01-1B		
Group Control Adapter PCB (Connects to external BMS)			KRP4A71		
Condensate Pump			DACA-CP1-1		

* Optional face plates available to provide a more intuitive user interface and disable specific functions

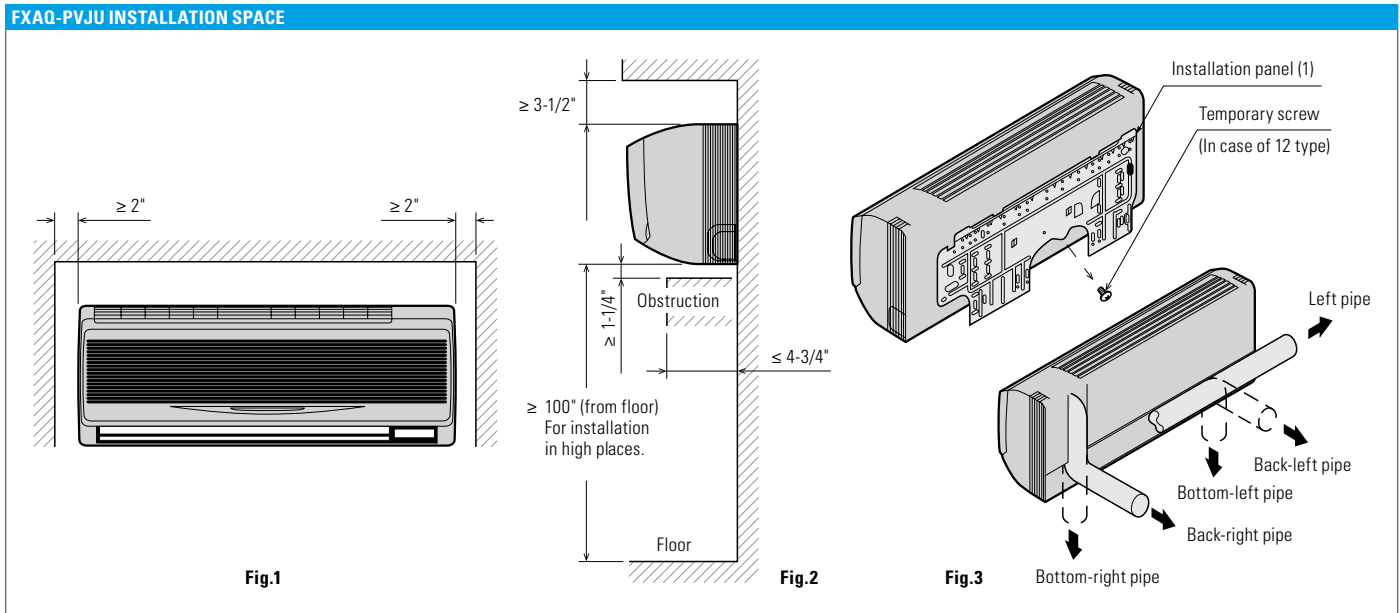

INDOOR UNITS



Outside Air
Integration Possible



Filter
Included

Versatile, Logical, Durable, Quiet

The ideal way to save space, our floor-standing units can easily be installed along a perimeter wall. The air distribution from these models will allow you to find the right balance for classrooms, churches, office hallways or similar spaces.

Features and Benefits

- Ideal for installation beneath a window
- Unit requires minimal installation space
- Fitted with a washable long-life filter
- Remote-control options available
- Space-saving unit can be freestanding or wall-mounted
- Models range from 7.5 MBH to 24 MBH



BRC1E73 (option)



BRC2A71 (option)



BRC4C82 (option)

Applications

- Multi-family residences
- Single-family residences
- Churches
- Historic buildings
- Schools
- Offices



FXLQ-MVJU9 SPECIFICATIONS			0.6 TON	0.75 TON	1 TON	1.5 TON	2 TON
Model Name			FXLQ07MVJU9	FXLQ09MVJU9	FXLQ12MVJU9	FXLQ18MVJU9	FXLQ24MVJU9
Power Supply	V/ph/Hz	208-230/1/60					
Rated Cooling Capacity	BTU/h	7,500	9,500	12,000	18,000	24,000	
Rated Heating Capacity	BTU/h	8,500	10,500	13,500	20,000	27,000	
Airflow Rate (H/L)	CFM	245/210		280/210	490/380		560/420
Weight	lbs	58		66	80		
Height	in.	23-5/8					
Width	in.	39-3/8		44-7/8	55-7/8		
Depth	in.	8-3/4					
Sound Pressure (H/L)	dB(A)	35/32		36/33	40/35	41/36	
Condensate Pipe Connection	in. O.D.	27/32					
Pipe Connections	Gas	in. 1/2 (Flare)				5/8 (Flare)	
	Liquid	in. 1/4 (Flare)				3/8 (Flare)	
Refrigerant		R-410A					
Refrigerant Control		Electronic Expansion Valve					
Maximum Overcurrent Protective Device	A	15					
Minimum Circuit Amps	A	0.3		0.5	0.6		
Protection Devices		Fuse and Fan Motor Thermal Protector					
External Finish		Ivory White Casing					
Standard Filter Type		Resin Net (with Mold Resistant)					

Nominal Conditions:

Cooling Mode
 Indoor: 80 °F DB / 67 °F WB
 Outdoor: 95 °F DB
 Pipe Length: 25 ft.
 Level Difference: 0 ft.

Heating Mode
 Indoor: 70 °F DB
 Outdoor: 47 °F DB / 43 °F WB
 Pipe Length: 25 ft.
 Level Difference: 0 ft.

Note: Specifications are subject to change without notice.

FXLQ-MVJU9 ACCESSORIES						
Model Name	FXLQ12MVJU9	FXLQ18MVJU9	FXLQ24MVJU9	FXNQ12MVJU9	FXNQ18MVJU9	FXNQ24MVJU9
Navigation Remote Controller*				BRC1E73		
Simplified Wired Remote Controller*				BRC2A71		
Wireless Remote Controller				BRC4C82		
Remote Sensor Kit				KRCS01-1B		
Wiring Adapter PCB (interface with aux/primary heater, humidifier, OA damper/fan)				KRP1C74		
Group Control Adapter PCB (connects to external BMS)				KRP4A71		

* Optional face plates available to provide a more intuitive user interface and disable specific functions

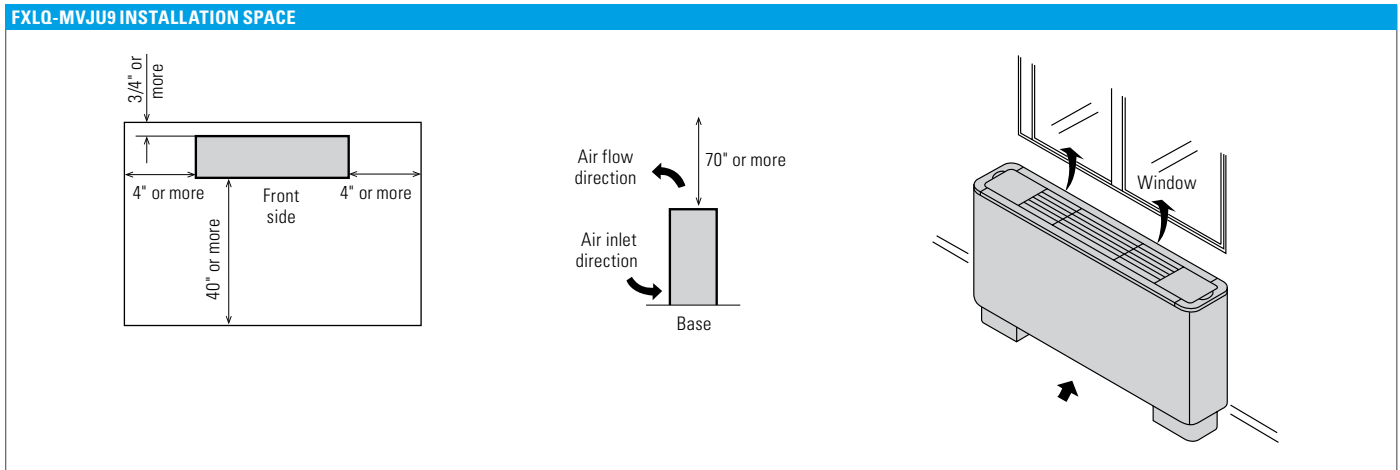



Outdoor Units



Air-Cooled Condensers

VRV IV

Heat Pump & Heat Recovery

6 to 38¹ Tons 208-230V/60Hz/3ph or 460V/60Hz/3ph

Daikin's VRV IV systems integrate advanced technology to provide comfort control to help maximize energy efficiency and reliability. Currently available in heat pump and heat recovery configurations, VRV IV provides a solution for multi-family residential to large commercial applications desiring heating or cooling. VRV IV is optimized for low total Life Cycle Cost (LCC) with larger capacity single modules (now range up to 14 Tons), improved seasonal efficiency, as compared to VRV III, with automatic and customizable Variable Refrigerant Temperature (VRT) climate tuning and outstanding warranty² with 10 year compressor and parts limited warranty as standard.



The VRV IV is the first variable refrigerant flow (VRF) system to be assembled in North America.

VRV III

Heat Recovery

6 to 12 Tons 208-230V/60Hz/3ph or 6 to 10 Tons 480V/60Hz/3ph

- Advanced continuous heating during defrost cycle for single module systems
- Variable Refrigerant Temperature (VRT) control
- Extended operating range with heating function down to -4°F ambient air temperature



Air-Cooled Condensers,

1 Phase Power Supply

VRV III-S

Heat Pump

3 and 4 Tons 208-230V/60Hz/1ph

Ideal for residential and light commercial applications, VRV III-S air cooled systems are available in 3 and 4 tons and can operate up to 8 fan coil units. These systems provide individual zone control and advanced zoning capabilities in an innovative space saving design.



NEW Water-Cooled Condensers

VRV IV

W-Series Water Cooled System

Heat Pump or Heat Recovery

6 to 21 Tons 208-230V/60Hz/3ph or 460V/60Hz/3ph

Great for both light and large commercial applications, the VRV IV W-Series provides cold climate capabilities in a lightweight, compact design. Available as a unified heat pump or heat recovery solution, the VRV IV W-Series offers an energy-saving alternative to centralized systems.



¹ Maximum 34 tons for Heat Pump

² Complete warranty details available from your local distributor or manufacturer's representative or at www.daikincomfort.com.



Local assembly of products enables Daikin to react fast to changes in the marketplace and truly optimize the product for the North American market.

VRV IV

Air-Cooled Heat Recovery

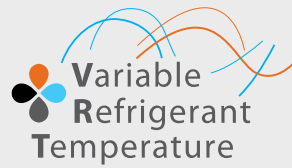

Daikin's VRV IV systems integrate advanced technology to provide comfort control to help maximize energy efficiency and reliability. VRV IV provides a heating and cooling solution for multi-family residential to large commercial applications. Daikin VRV IV is the first variable refrigerant flow (VRF) system to be assembled in North America.

Features and Benefits

- Total comfort solution for heating, cooling, ventilation and controls
- All inverter compressors and inverter fan motors optimize part load efficiency.
- Redesigned and optimized for low total Life Cycle Cost (LCC)
- New single/multiple port branch selector boxes provide compact dimensions and a wide range of product offerings (single, 4, 6, 8, 10 and 12 port options)
- Reduced install cost and increased flexibility as compared to VRV III with larger capacity single modules up to 14 Tons and system capacity up to 38 Tons
- Efficiency improved over VRV III by an average of 21% with IEER Values now up to 29.3
- Improved seasonal efficiency as compared to VRV III with automatic and customizable Variable Refrigerant Temperature (VRT) climate tuning
- Outstanding warranty* with 10 year compressor and parts limited warranty as standard

VRV IV



- Reduced commissioning time vs. VRV III with VRV configurator software and Graphical User Interface (GUI)
- Design flexibility with long piping lengths up to 3,280 ft. total and up to 100 ft. vertical separation between indoor units
- Take advantage of Daikin's unique zone and centralized controls that are optimized for the specific needs of North America

* Complete warranty details available from your local distributor or manufacturer's representative or at www.daikincomfort.com.

OUTDOOR UNITS



VRV IV CERTIFIED DATA - HEAT RECOVERY, 208-230V/60HZ/3PH AND 460V/60HZ/3PH

Product #	IEER Non-Ducted	IEER Ducted	IEER Mixed	SCHE Non-Ducted	SCHE Ducted	SCHE Mixed	COP @ 47°F Non-Ducted	COP @ 47°F Ducted	COP @ 47°F Mixed	COP @ 17°F Non-Ducted	COP @ 17°F Ducted	COP @ 17°F Mixed	EER Non-Ducted	EER Ducted	EER Mixed
REYQ72T	26.20	20.80	23.50	27.80	22.60	25.20	4.29	3.82	4.06	2.77	2.63	2.70	15.80	13.40	14.60
REYQ96T	29.30	21.00	25.15	27.30	23.00	25.15	4.25	3.72	3.99	2.63	2.31	2.47	15.10	13.10	14.10
REYQ120T	25.40	20.70	23.05	27.90	25.10	26.50	3.98	3.51	3.75	2.54	2.32	2.43	13.90	12.60	13.25
REYQ144T	24.20	20.70	22.45	25.50	23.80	24.65	3.81	3.55	3.68	2.56	2.35	2.46	12.90	11.90	12.40
REYQ168T	22.00	19.50	20.75	26.60	22.80	24.70	3.77	3.33	3.55	2.32	2.15	2.24	11.70	11.30	11.50
REYQ192T	22.90	20.40	21.65	26.60	22.90	24.75	3.84	3.67	3.76	2.55	2.38	2.47	12.50	12.60	12.55
REYQ216T	22.90	20.20	21.55	25.60	22.50	24.05	3.73	3.67	3.70	2.45	2.28	2.37	12.50	12.40	12.45
REYQ240T	21.90	19.20	20.55	25.60	22.70	24.15	3.67	3.55	3.61	2.48	2.31	2.40	12.20	11.60	11.90
REYQ264T	21.60	18.10	19.85	24.40	22.00	23.20	3.55	3.38	3.47	2.42	2.26	2.34	11.80	10.50	11.15
REYQ288T	21.40	18.20	19.80	23.30	21.40	22.35	3.51	3.26	3.39	2.41	2.24	2.33	11.80	10.90	11.35
REYQ312T	20.20	17.80	19.00	23.60	20.30	21.95	3.56	3.22	3.39	2.41	2.24	2.33	11.30	10.60	10.95
REYQ336T	19.00	17.00	18.00	23.20	20.40	21.80	3.52	3.20	3.36	2.18	2.06	2.12	10.70	10.00	10.35
REYQ360T	19.60	17.90	18.75	22.60	20.20	21.40	3.51	3.31	3.41	2.42	2.17	2.30	10.80	11.00	10.90
REYQ384T	18.30	16.60	17.45	22.40	18.70	20.55	3.21	3.21	3.21	2.34	2.06	2.20	9.80	9.80	9.80
REYQ408T	17.20	16.50	16.85	21.80	18.30	20.05	3.21	3.20	3.21	2.09	2.06	2.08	9.80	9.70	9.75
REYQ432T	16.20	16.50	16.35	21.10	18.10	19.60	3.21	3.20	3.21	2.08	2.06	2.07	9.80	9.70	9.75
REYQ456T	16.20	15.90	16.05	20.90	17.90	19.40	3.21	3.20	3.21	2.07	2.05	2.06	9.50	9.50	9.50

Certified efficiency data in accordance with ANSI/AHRI Standard 1230 2010, "Performance Rating of Variable Refrigerant Flow (VRF) Multi-Split Air Conditioning and Heat Pump Equipment" for the VRV Series. The VRV IV Series has been designed and optimized to meet or exceed the latest minimum efficiency requirements in 10 C.F.R. Part 431 as determined by the U.S. Department of Energy (DOE) and baseline efficiencies as defined by ASHRAE 90.1 2010. Systems under 65MBH are currently certified to AHRI 210/240. IEER ratings are as defined in ASHRAE 90.1 2010.

OUTDOOR UNITS

DETAILED OPERATION RANGES FOR VRV IV REYQ-T HEAT RECOVERY OUTDOOR UNITS

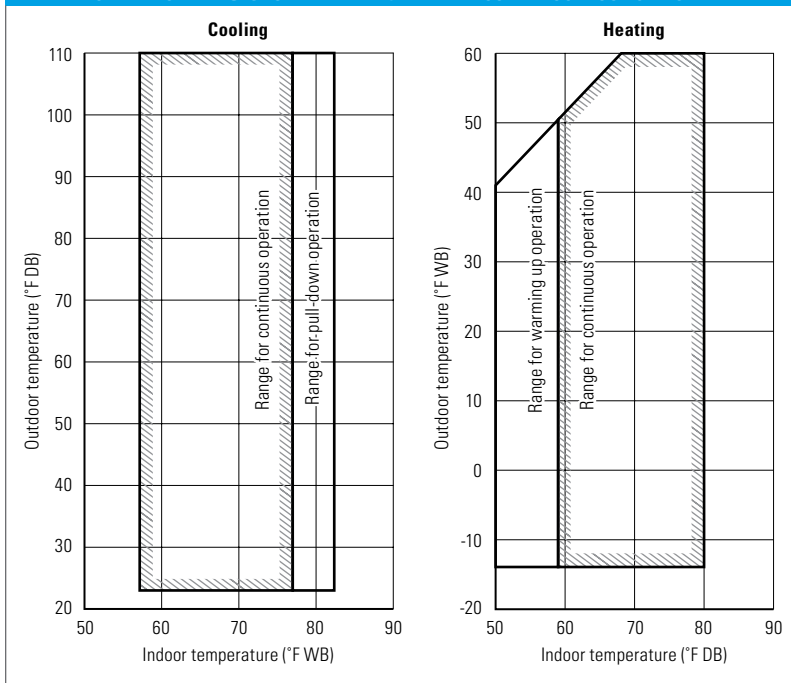

TECHNICAL COOLING FEATURE FOR VRV IV REYQ-T HEAT RECOVERY OUTDOOR UNITS

Technical Cooling - Cooling operation extended from 23°F ambient air temperature down to -4°F

The Technical Cooling feature is engaged by field settings on the outdoor unit and on branch selector boxes. It requires addition of wind covers to the unit and allows operation down to -4° FDB ambient temperature in cooling mode.

See the Engineering Data book for complete application rules and contact your local Daikin representative for wind cover specification requirements.

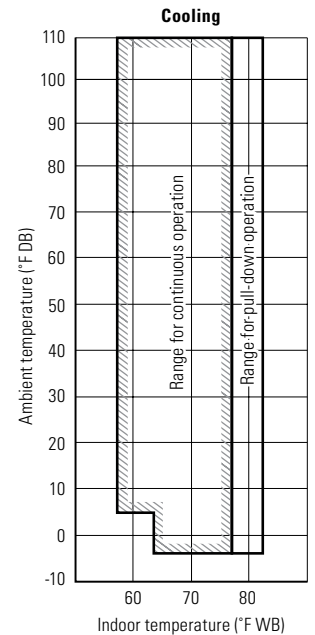

VRV IV

Air-Cooled Heat Recovery (continued)

TECHNICAL DATA FOR VRV IV REYQ-TTJU/TYDN HEAT RECOVERY OUTDOOR UNITS

		6 Ton	8 Ton	10 Ton	12 Ton	14 Ton	16 Ton	18 Ton	20 Ton		
Model	208-230V/3Ph/60Hz	REYQ72TTJU	REYQ96TTJU	REYQ120TTJU	REYQ144TTJU	REYQ168TTJU	REYQ192TTJU	REYQ216TTJU	REYQ240TTJU		
	460V/3Ph/60Hz	REYQ72TYDN	REYQ96TYDN	REYQ120TYDN	REYQ144TYDN	REYQ168TYDN	REYQ192TYDN	REYQ216TYDN	REYQ240TYDN		
Combination							1 x REYQ120T 1 x REYQ72T	1 x REYQ120T 1 x REYQ96T	1 x REYQ144T 1 x REYQ96T		
Performance	Rated Cooling Capacity	BTU/h	67,000	90,000	111,000	134,000	156,000	180,000	200,000	222,000	
	Rated Heating Capacity	BTU/h	75,000	100,000	126,000	150,000	176,000	200,000	226,000	250,000	
	Sound Pressure	dB(A)	58	61		65		63	64	66	
	IEER (Ducted / Non-Ducted)		20.8 / 26.2	21.0 / 29.3	20.7 / 25.4	20.7 / 24.2	19.5 / 22.0	20.4 / 22.9	20.2 / 22.9	19.2 / 21.9	
	Airflow	CFM	5,544	5,827	6,286	8,228		5,544 + 6,286	5,827 + 6,286	5,827 + 8,228	
	Fan ESP, Standard/Max	in. WG	0.12 / 0.32								
Compressor	Compressors, all inverter	Qty	1	2			3		4		
	Revolutions per minute	RPM	3600	3630, 3630	4470, 4470	4440, 4440	5190, 5190	4080, (4290, 4290)	(4170, 4170) x 2	(4050, 4050), (4110, 4110)	
	Capacity Control Range	%	15-100	11-100	10-100			5-100			
Refrigerant Piping, Layout	Maximum Vertical Pipe Length Above Unit	ft.	164 (295 With Field Setting)								
	Maximum Vertical Pipe Length Below Unit	ft.	131 (195 With Field Setting)								
	Maximum Vertical Pipe Length Between IDU	ft.	100								
	Maximum Actual Pipe Length	ft.	541								
	Maximum Equivalent Pipe Length	ft.	620								
	Maximum Total Pipe Length	ft.	3,282								
Refrigerant Piping, Connections	Liquid Pipe, Main Line	in.	ø3/8 (9.5) C1220T (Braze Connection)		ø1/2 (12.7) C1220T (Braze Connection)		ø5/8 (15.9) C1220T (Braze Connection)				
	Suction Gas Pipe, Main Line	in.	ø3/4 (19.1) C1220T (Braze Connection)	ø7/8 (22.2) C1220T (Braze Connection)	ø1-1/8 (28.6) C1220T (Braze Connection)				ø1-3/8 (34.9) C1220T (Braze Connection)		
	Discharge Gas Pipe, Main Line	in.	ø5/8 (15.9) C1220T (Braze Connection)	ø3/4 (19.1) C1220T (Braze Connection)	ø7/8 (22.2) C1220T (Braze Connection)		ø1-1/8 (28.6) C1220T (Braze Connection)				
Connection Ratio	Standard Connectable Indoor Unit Ratio	%	50 - 200								
	Maximum Number of Indoor Units	Qty	12	16	20	25	29	33	37	41	
Electrical	Maximum Overcurrent Protection, MOP (REYQ-TT / REYQ-TY)	A	35/20	45/25	50/25	70/40		35 + 50 / 20 + 25	45 + 50 / 25 + 25	45 + 70 / 25 + 40	
	Minimum Circuit Amps, MCA (REYQ-TT / REYQ-TY)	A	30.2 / 15.2	38 / 21.1	43 / 21.1	55 / 31.9	61.9 / 36.1	30.2 + 43 / 15.2 + 21.1	38 + 43 / 21.1 + 21.1	38 + 55 / 21.1 + 31.9	
	Compressor Rated Load Amps, RLA (REYQ-TT / REYQ-TY)	A	20.7 / 9.4	13.7 + 13.7 / 6.2 + 6.2	15 + 15 / 6.8 + 6.8	16.2 + 22.6 / 7.3 + 10.3	17.4 + 24.4 / 7.9 + 11.1	20.7 + (15 + 15) / 9.4 + (6.8 + 6.8)	(13.7 + 13.7) + (15 + 15) / (6.2 + 6.2) + (6.8 + 6.8)	(13.7 + 13.7) + (16.2 + 22.6) / (6.2 + 6.2) + (7.3 + 10.3)	
Unit	Factory Refrigerant Charge	lbs	21.9	25.8			21.9 + 25.8		25.8 + 25.8		
	Weight (REYQ-TT / REYQ-TY)	lbs	507 / 527	703 / 717	703 / 717	780 / 794		507 + 703 / 527 + 717	703 + 703 / 717 + 717	703 + 780 / 717 + 794	
	Dimensions (H x W x D)	in.	66-11/16 x 36-11/16 x 30-3/16	66-11/16 x 48-7/8 x 30-3/16			(66-11/16 x 36-11/16 x 30-3/16) + (66-11/16 x 36-11/16 x 30-3/16)		(66-11/16 x 48-7/8 x 30-3/16) + (66-11/16 x 48-7/8 x 30-3/16)		

OPERATION RANGE FOR ALL VRV IV HEAT RECOVERY OUTDOOR UNITS

Cooling °F DB	23 – 122
Heating °F WB	-13 – 60

	22 Ton	24 Ton	26 Ton	28 Ton	30 Ton	32 Ton	34 Ton	36 Ton	38 Ton
	REYQ264TTJU	REYQ288TTJU	REYQ312TTJU	REYQ336TTJU	REYQ360TTJU	REYQ384TTJU	REYQ408TTJU	REYQ432TTJU	REYQ456TTJU
	REYQ264TYDN	REYQ288TYDN	REYQ312TYDN	REYQ336TYDN	REYQ360TYDN	REYQ384TYDN	REYQ408TYDN	REYQ432TYDN	REYQ456TYDN
	1 x REYQ144T 1 x REYQ120T	2 x REYQ144T	1 x REYQ168T 1 x REYQ144T	2 x REYQ168T	3 x REYQ120T	1 x REYQ168T 1 x REYQ120T 1 x REYQ96T	1 x REYQ168T 1 x REYQ144T 1 x REYQ96T	3 x REYQ144T	1 x REYQ168T 2 x REYQ144T
	246,000	268,000	290,000	312,000	334,000	356,000	380,000	400,000	415,000
	276,000	300,000	326,000	352,000	376,000	415,000	415,000	425,000	435,000
	66	68			66	68	69	70	
	18.1 / 21.6	18.2 / 21.4	17.8 / 20.2	17.0 / 19.0	17.9 / 19.6	16.6 / 18.3	16.5 / 17.2	16.5 / 16.2	15.9 / 16.2
	6,286 + 8,228	8,228 + 8,228	8,228 + 8,228		6,286 + 6,286 + 6,286	5,827 + 6,286 + 8,228	5,827 + 8,228 + 8,228	8,228 + 8,228 + 8,228	
					0.12/0.32				
	4				6				
	(4710, 4710), (4800, 4800)	(4740, 4740) x 2	(5190, 5190) x 2		(5010, 5010) x 3	(5070, 5070) x 2, (5160, 5160)	(5040, 5040), (5130, 5130) x 2	(5220, 5220) x 3	(5730, 5730) x 3
	5-100				3-100				
	164 (295 With Field Setting)								
	131 (195 With Field Setting)								
	100								
	541								
	620								
	3,282								
	ø3/4 (19.1) C1220T (Brazing Connection)								
	ø1-3/8 (34.9) C1220T (Brazing Connection)				ø1-5/8 (41.3) C1220T (Brazing Connection)				
	ø1-1/8 (28.6) C1220T (Brazing Connection)				ø1-3/8 (34.9) C1220T (Brazing Connection)				
	50 - 200								
	45	49	54	58	64				
	50 + 70 / 25 + 40	70 + 70 / 40 + 40			50 + 50 + 50 / 25 + 25 + 25	45 + 50 + 70 / 25 + 25 + 40	45 + 70 + 70 / 25 + 40 + 40	70 + 70 + 70 / 40 + 40 + 40	70 + 70 + 70 / 40 + 40 + 40
	43 + 55 / 21.1 + 31.9	55 + 55 / 31.9 + 31.9	55 + 61.9 / 31.9 + 36.1	61.9 + 61.9 / 36.1 + 36.1	43 + 43 + 43 / 21.1 + 21.1 + 21.1	38 + 43 + 61.9 / 21.1 + 21.1 + 21.1	38 + 55 + 61.9 / 21.1 + 31.9 + 36.1	55 + 55 + 55 / 31.9 + 31.9 + 31.9	55 + 55 + 61.9 / 31.9 + 31.9 + 36.1
	(15 + 15) + (16.2 + 22.6) / (6.8 + 6.8) + (7.3 + 10.3)	(16.2 + 22.6 x 2 / (7.3 + 10.3) x 2	(16.2 + 22.6) + (17.4 + 24.4) / (7.3 + 10.3) + (7.9 + 11.1)	(17.4 + 24.4) x 2 / (7.9 + 11.1) x 2	(15 + 15) x 3 / (6.8 + 6.8) x 3	(13.7 + 13.7) + (16.2 + 22.6) + (17.4 + 24.4) / (6.2 + 6.2) + (6.8 + 6.8) + (7.9 + 11.1)	(13.7 + 13.7) + (16.2 + 22.6) + (17.4 + 24.4) / (6.2 + 6.2) + (7.3 + 10.3) + (7.9 + 11.1)	(16.2 + 22.6) x 3 / (7.3 + 10.3) x 3	(16.2 + 22.6) x 2 + (17.4 + 24.4) / (7.3 + 10.3) x 2 + (7.9 + 11.1)
	25.8 + 25.8				25.8 + 25.8 + 25.8				
	703 + 780 / 717 + 794	780 + 780 / 794 + 794			703 + 703 + 703 / 717 + 717 + 717	703 + 703 + 780 / 717 + 717 + 794	780 + 780 + 780 / 717 + 794 + 794	780 + 780 + 780 / 794 + 794 + 794	
	(66-11/16 x 48-7/8 x 30-3/16) + (66-11/16 x 48-7/8 x 30-3/16)				(66-11/16 x 48-7/8 x 30-3/16) + (66-11/16 x 48-7/8 x 30-3/16) + (66-11/16 x 48-7/8 x 30-3/16)				

OUTDOOR UNITS

For additional technical information please refer to specific Engineering Data Books.

VRV IV

Air-Cooled Heat Pump

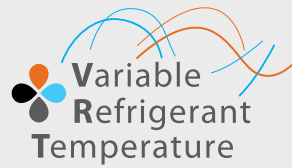

Daikin's VRV IV systems integrate advanced technology to provide comfort control to help maximize energy efficiency and reliability. VRV IV provides a solution for multi-family residential to large commercial applications desiring heating or cooling. The VRV IV is the first variable refrigerant flow (VRF) system to be assembled in North America.

Features and Benefits

- Total comfort solution for heating, cooling, ventilation and controls
- Redesigned and optimized for total Life Cycle Cost (LCC)
- Reduced install cost and increased flexibility as compared to VRV III with larger capacity single modules up to 14 Tons and system capacity up to 34 Tons
- Efficiency improved over VRV III by an average of 11% with IEER Values now up to 28
- Improved seasonal efficiency as compared to VRV III with automatic and customizable Variable Refrigerant Temperature (VRT) climate tuning
- Outstanding warranty* with 10 year compressor and parts limited warranty as standard
- Reduced commissioning time vs. VRV III with VRV configurator software and Graphical User Interface (GUI)

VRV IV



- Design flexibility with long piping lengths up to 3,280 ft. total and 100 ft. vertical separation between indoor units
- Take advantage of Daikin's unique zone and centralized controls that are optimized for the specific needs of North America

* Complete warranty details available from your local distributor or manufacturer's representative or at www.daikincomfort.com.

OUTDOOR UNITS



VRV IV CERTIFIED DATA - HEAT PUMP, 208-230V/60HZ/3PH AND 460V/60HZ/3PH

Product #	Capacity (Tons)	IEER Non-Ducted	IEER Ducted	IEER Mixed	COP @ 47°F Non-Ducted	COP @ 47°F Ducted	COP @ 47°F Mixed	COP @ 17°F Non-Ducted	COP @ 17°F Ducted	COP @ 17°F Mixed	EER Non-Ducted	EER Ducted	EER Mixed
RXYQ72T	6	26.50	22.80	24.65	4.21	3.58	3.90	2.49	2.25	2.37	15.00	13.50	14.25
RXYQ96T	8	28.00	22.70	25.35	4.59	3.99	4.29	2.86	2.61	2.74	15.10	13.00	14.05
RXYQ120T	10	23.50	21.40	22.45	3.79	3.46	3.63	2.61	2.58	2.60	13.20	12.10	12.65
RXYQ144T	12	24.10	21.00	22.55	4.10	3.72	3.91	2.33	2.20	2.27	12.30	11.50	11.90
RXYQ168T	14	22.10	19.80	20.95	3.74	3.49	3.62	2.27	2.27	2.31	10.60	10.60	10.60
RXYQ192T	16	22.20	20.70	21.45	3.80	3.60	3.70	2.62	2.40	2.34	11.90	12.30	12.10
RXYQ216T	18	20.50	20.00	20.25	3.83	3.65	3.74	2.62	2.48	2.55	11.60	11.70	11.65
RXYQ240T	20	20.80	18.40	19.60	3.63	3.55	3.59	2.62	2.43	2.53	11.50	11.60	11.55
RXYQ264T	22	20.30	19.30	19.80	3.33	3.35	3.34	2.43	2.30	2.37	10.90	10.50	10.70
RXYQ288T	24	20.10	19.30	19.70	3.25	3.31	3.28	2.07	2.13	2.10	10.50	10.50	10.50
RXYQ312T	26	19.90	18.80	19.35	3.30	3.26	3.28	2.32	2.20	2.26	9.80	9.80	9.80
RXYQ336T	28	19.50	19.00	19.00	3.22	3.20	3.21	2.38	2.27	2.33	9.50	9.50	9.50
RXYQ360T	30	19.40	18.50	18.95	3.46	3.25	3.36	2.47	2.41	2.44	10.30	10.90	10.60
RXYQ384T	32	20.40	18.50	19.45	3.30	3.26	3.28	2.28	2.28	2.28	9.50	10.00	9.75
RXYQ408T	34	20.90	19.00	19.95	3.24	3.24	3.24	2.18	2.10	2.14	9.50	9.50	9.50

Certified efficiency data in accordance with ANSI/AHRI Standard 1230 2010, "Performance Rating of Variable Refrigerant Flow (VRF) Multi-Split Air Conditioning and Heat Pump Equipment" for the VRV Series. The VRV IV Series has been designed and optimized to meet or exceed the latest minimum efficiency requirements in 10 C.F.R. Part 431 as determined by the U.S. Department of Energy (DOE) and baseline efficiencies as defined by ASHRAE 90.1 2010. Systems under 65MBH are currently certified to AHRI 210/240. IEER ratings are as defined in ASHRAE 90.1 2010.

DETAILED OPERATION RANGES FOR VRV IV RXYQ-T HEAT PUMP OUTDOOR UNITS

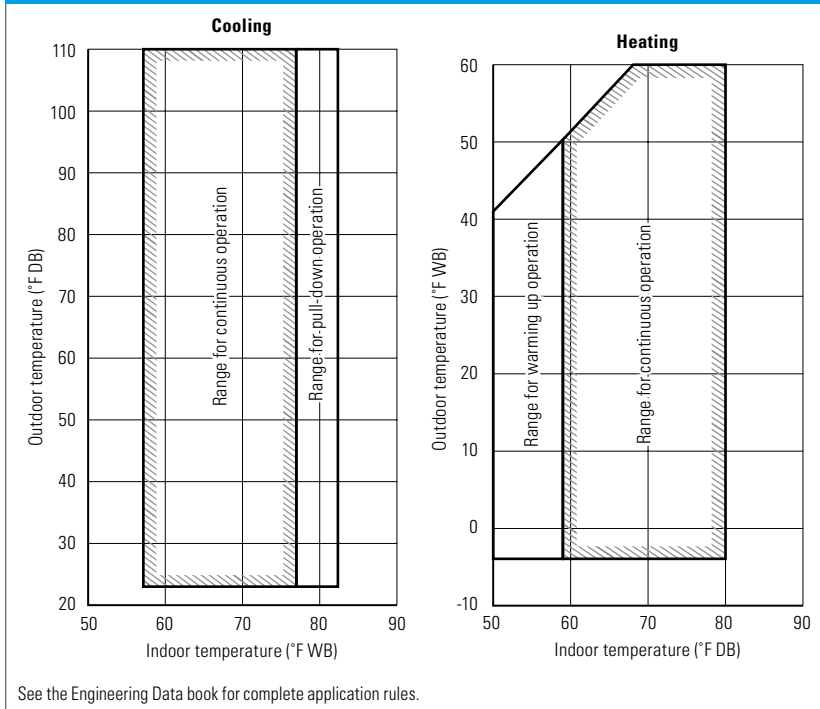

OUTDOOR UNITS

VRV IV

Air-Cooled Heat Pump (continued)

TECHNICAL DATA FOR VRV IV RXYQ-TTJU/TYDN HEAT PUMP OUTDOOR UNITS

		6 Ton	8 Ton	10 Ton	12 Ton	14 Ton	16 Ton	18 Ton	20 Ton		
Model	208-230V/3Ph/60Hz	RXYQ72TTJU	RXYQ96TTJU	RXYQ120TTJU	RXYQ144TTJU	RXYQ168TTJU	RXYQ192TTJU	RXYQ216TTJU	RXYQ240TTJU		
	460V/3Ph/60Hz	RXYQ72TYDN	RXYQ96TYDN	RXYQ120TYDN	RXYQ144TYDN	RXYQ168TYDN	RXYQ192TYDN	RXYQ216TYDN	RXYQ240TYDN		
Combination							1 x RXYQ120T 1 x RXYQ72T	1 x RXYQ120T 1 x RXYQ96T	2 x RXYQ120T		
Performance	Rated Cooling Capacity	BTU/h	69,000	92,000	114,000	138,000	160,000	184,000	206,000	228,000	
	Rated Heating Capacity	BTU/h	77,000	103,000	129,000	154,000	180,000	206,000	231,000	257,000	
	Sound Pressure	dB(A)	58	61		64	65	63		64	
	IEER (Ducted / Non-Ducted)		22.8 / 26.5	22.7 / 28	21.4 / 23.5	21 / 24.1	19.8 / 22.1	20.7 / 22.2		20 / 20.5	18.4 / 20.8
	Airflow	CFM	5,544	5,827	6,286	8,228		5,544 + 6,286		5,827 + 6,286	6,286 + 6,286
	Fan ESP, Standard/Max	in. WG	0.12 / 0.32								
Compressor	Compressors, all inverter	Qty	1			2					
	Revolutions per minute	RPM	7668	7650	7746	7008 + 7608	7680 + 8280	7668, 7746	7650, 7746	7746, 7746	
	Capacity Control Range	%	20-100	16-100	15-100	11-100	10-100	17-100	15-100		
Refrigerant Piping, Layout	Maximum Vertical Pipe Length Above Unit	ft.	164 (295 With Field Setting)								
	Maximum Vertical Pipe Length Below Unit	ft.	131 (295 With Field Setting)								
	Maximum Vertical Pipe Length Between IDU	ft.	100								
	Maximum Actual Pipe Length	ft.	541								
	Maximum Equivalent Pipe Length	ft.	620								
	Maximum Total Pipe Length	ft.	3,282								
Refrigerant Piping, Connections	Liquid Pipe, Main Line	in.	ø3/8 (9.5) C1220T (Brazeing Connection)		ø1/2 (12.7) C1220T (Brazeing Connection)		ø5/8 (15.9) C1220T (Brazeing Connection)				
	Suction Gas Pipe, Main Line	in.	ø3/4 (19.1) C1220T (Brazeing Connection)	ø7/8 (22.2) C1220T (Brazeing Connection)	ø1-1/8 (28.6) C1220T (Brazeing Connection)				ø1-3/8 (34.9) C1220T (Brazeing Connection)		
Connection Ratio	Standard Connectable Indoor Unit Ratio	%	50 - 200								
	Maximum Number of Indoor Units	Qty	12	16	20	25	29	33	37	41	
Electrical	Maximum Overcurrent Protection, MOP (RXYQ-TT / RXYQ-TY)	A	35 / 20	45 / 25		60 / 35	60 / 35	35 + 45 / 20 + 25		45 + 45 / 25+25	45 + 45 / 25 + 25
	Minimum Circuit Amps, MCA (RXYQ-TT / RXYQ-TY)	A	27.6 / 12.3	36.3 / 20.6	36.3 / 20.6	55.1 / 25.9	55.1 / 25.9	27.6 + 36.3 / 12.3 + 20.6		36.3 + 36.3 / 20.6 + 20.6	36.3 + 36.3 / 20.6 + 20.6
	Compressor Rated Load Amps, RLA (RXYQ-TT / RXYQ-TY)	A	15.7 / 7.1	23.8 / 10.2	26.2 / 11.7	16.7 + 16.7 / 7.6 + 7.6	18.8 + 18.8 / 8.5 + 8.5	15.7 + 26.2 / 7.1 + 11.7		23.8 + 26.2 / 10.2 + 11.7	26.2 + 26.2 / 11.7 + 11.7
Unit	Factory Refrigerant Charge	lbs	13	22.7	22.9	18.1	17.2	13.0 + 22.9		22.7 + 22.9	22.9 + 22.9
	Weight (RXYQ-TT / RXYQ-TY)	lbs	435 / 451	525 / 553	528 / 556	695 / 709		435 + 528 / 451 + 556		525 + 528 / 553 + 556	528 + 528 / 566 + 556
	Dimensions (H x W x D)	in.	66-11/16 x 36-11/16 x 30-3/16	66-11/16 x 48-7/8 x 30-3/16				66-11/16 x 36-11/16 x 30-3/16 + 66-11/16 x 48-7/8 x 30-3/16		66-11/16 x 48-7/8 x 30-3/16 + 66-11/16 x 48-7/8 x 30-3/16	

OPERATION RANGE FOR ALL VRV IV HEAT PUMP OUTDOOR UNITS

Cooling °F DB	23 – 122
Heating °F WB	-4 – 60

	22 Ton	24 Ton	26 Ton	28 Ton	30 Ton	32 Ton	34 Ton
	RXYQ264TTJU	RXYQ288TTJU	RXYQ312TTJU	RXYQ336TTJU	RXYQ360TTJU	RXYQ384TTJU	RXYQ408TTJU
	RXYQ264TYDN	RXYQ288TYDN	RXYQ312TYDN	RXYQ336TYDN	RXYQ360TYDN	RXYQ384TYDN	RXYQ408TYDN
	1 x RXYQ144T 1 x RXYQ120T	2 x RXYQ144T	1 x RXYQ168T 1 x RXYQ144T	2 x RXYQ168T	3 x RXYQ120T	1 x RXYQ168T 1 x RXYQ120T 1 x RXYQ96T	1 x RXYQ168T 1 x RXYQ144T 1 x RXYQ96T
	251,000	274,000	297,000	320,000	342,000	365,000	380,000
	283,000	308,000	334,000	360,000	385,000	411,000	436,000
	66	67	68		66	68	
	19.3 / 20.3	19.3 / 20.1	18.8 / 19.9	18.5 / 19.5	18.5 / 19.4	18.5 / 20.4	19.0 / 20.9
	6286 + 8228	8228 + 8228		6286 + 6286 + 6286		5827 + 6286 + 8228	5827 + 8228 + 8228
	0.12 / 0.32						
	3	4		3		4	5
	7746, (7008, 7608)	(7008, 7608), (7008, 7608)	(7008, 7608), (7680, 8280)	(7680, 8280), (7680, 8280)	7746, 7746, 7746	7650, 7746, (7680, 8280)	7650, (7008, 7608), (7680, 8280)
	13-100	11-100	10-100		15-100	13-100	12-100
	164 (295 With Field Setting)						
	131 (295 With Field Setting)						
	100						
	541						
	620						
	3,282						
	ø3/4 (19.1) C1220T (Brazing Connection)						
	ø1-3/8 (34.9) C1220T (Brazing Connection)			ø1-5/8 (41.3) C1220T (Brazing Connection)			
	50 - 200						
	45	49	54	58	62	64	
	45 + 60 / 25 + 35	60 + 60 / 35 + 35			45 + 45 + 45 / 25 + 25 + 25	45 + 45 + 60 / 25 + 25 + 35	45 + 60 + 60 / 25 + 35 + 35
	36.3 + 55.1 / 20.6 + 25.9	55.1 + 55.1 / 25.9 + 25.9			36.3 + 36.3 + 36.3 / 20.6 + 20.6 + 20.6	36.3 + 36.3 + 55.1 / 20.6 + 20.6 + 25.9	36.3 + 55.1 + 55.1 / 20.6 + 25.9 + 25.9
	26.2 + (16.7 + 16.7) / 11.7 + (7.6 + 7.6)	(16.7 + 16.7) x 2 / (7.6 + 7.6) x 2	(16.7 + 16.7) + (18.8 + 18.8) / (7.6 + 7.6) + (8.5 + 8.5)	(18.8 + 18.8) x 2 / (8.5 + 8.5) x 2	26.2 + 26.2 + 26.2 / 11.7 + 11.7 + 11.7	23.8 + 26.2 + (18.8 + 18.8) / 10.2 + 11.7 + (8.5 + 8.5)	23.8 + (16.7 + 16.37) + (18.8 + 18.8) / 10.2 + (7.6 + 7.6) + (8.5 + 8.5)
	22.9 + 18.1	18.1 + 18.1	18.1 + 17.2	17.2 + 17.2	22.9 + 22.9 + 22.9	22.7 + 22.9 + 17.2	22.7 + 18.1 + 17.2
	528 + 695 / 556 + 709	695 + 695 / 709 + 709			528 + 528 + 528 / 556 + 556 + 556	525 + 528 + 695 / 553 + 556 + 709	525 + 695 + 695 / 553 + 709 + 709
	(66-11/16 x 48-7/8 x 30-3/16) + (66-11/16 x 48-7/8 x 30-3/16)				(66-11/16 x 48-7/8 x 30-3/16) + (66-11/16 x 48-7/8 x 30-3/16) + (66-11/16 x 48-7/8 x 30-3/16)		

OUTDOOR UNITS

For additional technical information please refer to specific Engineering Data Books.

VRV-III PC

Air-Cooled Heat Recovery

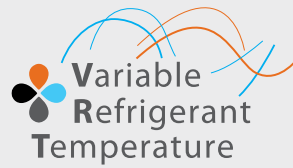

Daikin's VRV III systems integrate advanced technology to provide comfort control to help maximize energy efficiency. Available in heat recovery configurations, VRV III provides a solution for residential to large commercial applications desiring heating, cooling, or simultaneous operation.



VRV III

Features and Benefits

- Advanced continuous heating during defrost cycle and oil return for single module systems
- Variable Refrigerant Temperature (VRT) control
- Extended operating range with heating function -4°F ambient air temperature

OUTDOOR UNITS

VRV III PC CERTIFIED DATA - HEAT RECOVERY, 208-230V/60HZ/3PH AND 460V/3PH/60HZ													
Product#	Capacity (Tons)	IEER Non-Ducted	IEER Ducted	IEER Mixed	COP @ 47°F Non-Ducted	COP @ 47°F Ducted	COP @ 47°F Mixed	COP @ 17°F Non-Ducted	COP @ 17°F Ducted	COP @ 17°F Mixed	EER Non-Ducted	EER Ducted	EER Mixed
REYQ72PC	6	25.1	18.7	21.9	4.2	3.6	3.9	2.95	2.4	2.7	15.4	12.3	13.9
REYQ96PC	8	22.9	17.6	20.3	3.7	3.4	3.6	2.7	2.4	2.6	13.2	11.0	12.1
REYQ120PC	10	21.3	15.3	18.3	3.6	3.2	3.4	2.6	2.95	2.4	12.1	10.9	11.5
REYQ144PCTJ	12	18.9	15.3	17.1	3.6	3.2	3.4	2.95	2.95	2.3	11.2	10.0	10.6

Certified efficiency data in accordance with ANSI/AHRI Standard 1230 2010, "Performance Rating of Variable Refrigerant Flow (VRF) Multi-Split Air Conditioning and Heat Pump Equipment" for the VRV Series. The VRV III Series has been designed and optimized to meet or exceed the latest minimum efficiency requirements in 10 C.F.R. Part 431 as determined by the U.S. Department of Energy (DOE) and baseline efficiencies as defined by ASHRAE 90.1 2010. Systems under 65MBH are currently certified to AHRI 210/240. IEER ratings are as defined in ASHRAE 90.1 2010.



TECHNICAL DATA FOR VRV III PC REYQ-PC HEAT RECOVERY OUTDOOR UNITS						
Model	208-230V/3Ph/60Hz		6 Ton	8 Ton	10 Ton	12 Ton
	460V/3Ph/60Hz		REYQ72PCTJ REYQ72PCYD	REYQ96PCTJ REYQ96PCYD	REYQ120PCTJ REYQ120PCYD	REYQ144PCTJ -
Performance	Rated Cooling Capacity	BTU/h	69,000	92,000	114,000	138,000
	Rated Heating Capacity	BTU/h	77,000	103,000	129,000	154,000
	Sound Pressure (REYQ-PCT / REYQ-PCY)	dB(A)	58 / 58	58 / 61	60 / 61	62 / -
	IEER (Ducted / Non-Ducted)		18.7 / 25.1	17.6 / 22.9	15.3 / 21.3	15.3 / 18.9
	Airflow	CFM	6,700		7,410	8,300
	Fan ESP, Standard/Max	in. WG	0.12 / 0.32			
Compressor	Compressors, standard / inverter	Qty	2			
	Revolutions per minute	RPM	3720, 2900	6300, 2900	6300, 2900	7980, 7880
	Capacity Control Range	%	14-100			
			20-100			10-100
Refrigerant Piping, Layout	Maximum Vertical Pipe Length Above Unit	ft.	131 (295 With Field Setting)			
	Maximum Vertical Pipe Length Below Unit	ft.	164 (295 With Field Setting)			
	Maximum Vertical Pipe Length Between IDU	ft.	49			
	Maximum Actual Pipe Length	ft.	541			
	Maximum Equivalent Pipe Length	ft.	620			
	Maximum Total Pipe Length	ft.	3,282			
Refrigerant Piping, Connections	Liquid Pipe, Main Line	in.	ϕ3/8 (9.5) C1220T (Brazeing Connection)		ϕ1/2 (12.7) C1220T (Brazeing Connection)	
	Suction Gas Pipe, Main Line	in.	ϕ3/4 (19.1) C1220T (Brazeing Connection)	ϕ7/8 (22.2) C1220T (Brazeing Connection)	ϕ1-1/8 (28.6) C1220T (Brazeing Connection)	
	Discharge Gas Pipe, Main Line	in.	ϕ5/8 (15.9) C1220T (Brazeing Connection)	ϕ3/4 (19.1) C1220T (Brazeing Connection)		ϕ7/8 (22.2) C1220T (Brazeing Connection)
Connection Ratio	Standard Connectable Indoor Unit Ratio	%	36-93	48-124	60-156	72-187
	Maximum Number of Indoor Units	Qty	12	16	20	25
Electrical	Maximum Overcurrent Protection, MOP (REYQ-PCT / REYQ-PCY)	A	40 / 20	45 / 25	50 / 25	80 / -
	Minimum Circuit Amps, MCA (REYQ-PCT / REYQ-PCY)	A	36.1 / 16.0	43.8 / 20.4	44.2 / 20.5	72.2 / -
	Compressor Rated Load Amps, RLA (REYQ-PCT / REYQ-PCY)	A	4.8 + 14.0 / 2.4 + 7.0	8.4 + 14.0 / 4.2 + 7.0	12.0 + 13.6 / 6.0 + 6.8	14.3 + 14.3 / -
Unit	Factory Refrigerant Charge	lbs	22.7	23.4	23.8	24.5
	Weight (REYQ-PCT / REYQ-PCY)	lbs	730 / 732			
	Dimensions (H x W x D)	in.	66-1/8 x 51-3/16 x 30-1/8			

OPERATION RANGE FOR ALL VRV III PC HEAT RECOVERY OUTDOOR UNITS	
Cooling °F DB	23 - 122
Heating °F WB	-4 - 60

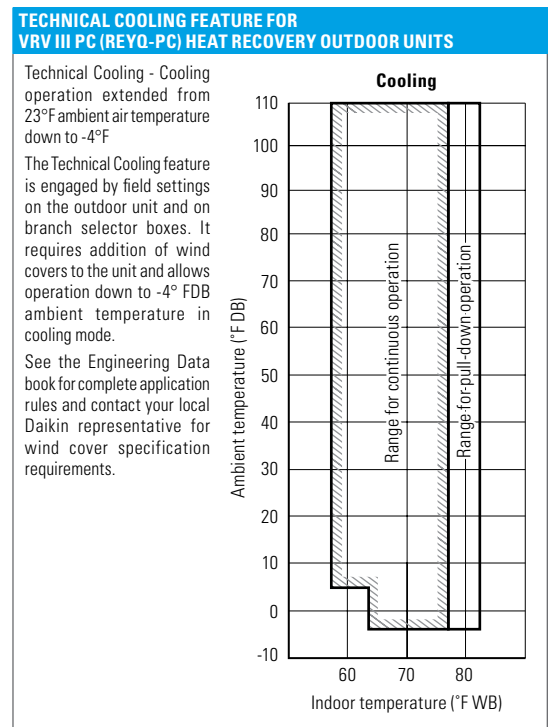
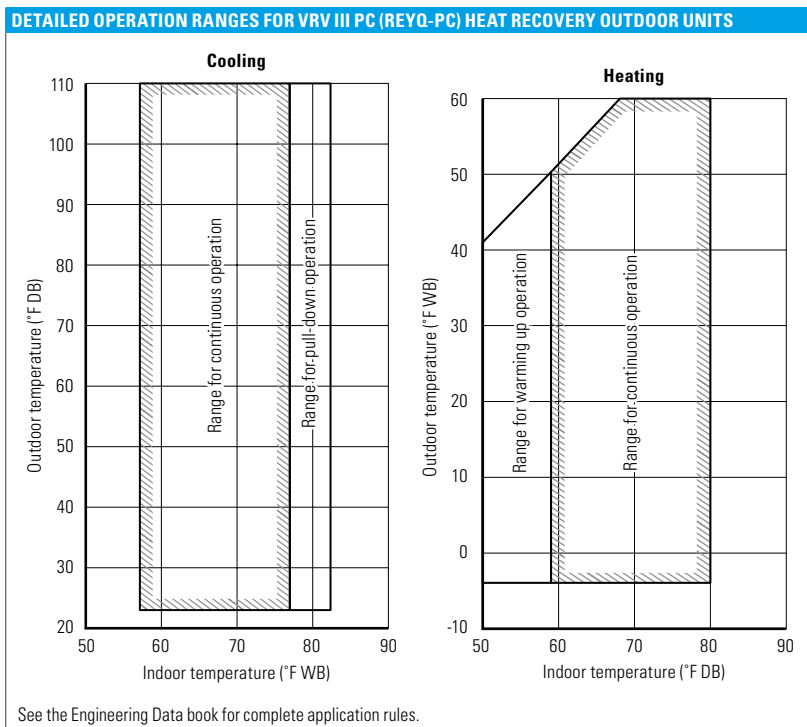

OUTDOOR UNITS

For additional technical information please refer to specific Engineering Data Books.

Heat Pump or Heat Recovery

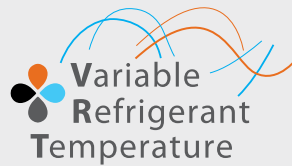

VRV IV W-Series systems are equivalent to 4-pipe chilled water systems, but also offer a viable alternative to Water Source Heat Pump solutions. Each connected indoor unit can provide heating and cooling independently to suit zone requirements making these systems suitable for both open plan, or cellular applications with different operation requirements.

Features and Benefits

- **Reliability, comfort and efficiency working together hand-in-hand** - All VRV IV W-Series incorporate Daikin's unique "variable speed" scroll compressor at the heart of the system. This provides the exact capacity where and when it is needed, along with outstanding reliability and high part-load operational efficiency.
- **Compact and lightweight**
 - Compact lightweight casing
 - Height: 39-3/8",
 - Weight: 330 lbs.
 - Install in a mechanical room, double-decker style if needed.
- **Increased efficiency with Variable Refrigerant Temperature (VRT) Control**
- **Wide water temperature operation range** - Can be applied to both geothermal and boiler/tower applications as standard with condenser water inlet temperature as low as 14°F in heating and 27°F in cooling is possible.

OUTDOOR UNITS

VRV IV
W Series Water Cooled System



Water side

Connects to cooling tower and/or boiler combination or set up as geothermal.

Refrigerant side

Connects to Daikin's line-up of VRV indoor units

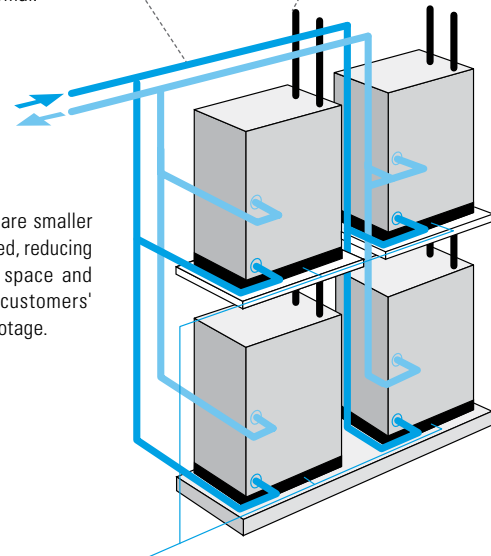

The condensers are smaller and can be stacked, reducing the installation space and increasing the customers' usable square footage.



The VRV IV W-Series design is based on a modular design concept. It is composed of unified condensing units that require simply connecting a two-pipe refrigerant network for heat pump applications or a three-pipe refrigerant network for heat recovery applications. All water-cooled condensers are of the same dimensions, and are available in 6 tons and 7 tons. This is a simple system that allows manifolding together up to three condensers to form one system of up to 21 tons (252 MBH). The condensers are designed for internal mounting only.

VRV-IV W-SERIES CERTIFIED DATA

System Type Function	System Name	Tonnage	Condensing Unit Models			Part Load						Full Load							
			Unit 1	Unit 2	Unit 3	IEER Non-Ducted	IEER Ducted	IEER Mixed	SCHE Non-Ducted	SCHE Ducted	SCHE Mixed	IEER Non-Ducted	IEER Ducted	IEER Mixed	COP @ 68°F Non-Ducted	COP @ 68°F Ducted	COP @ 68°F Mixed		
VRV IV W-Series 460V Heat Pump	RWEYQ72PCYD	6 Tons	RWEYQ72PCYD			24.1	22.3	23.2						14.0	14.0	14.0	4.89	4.78	4.89
	RWEYQ84PCYD	7 Tons	RWEYQ84PCYD			22.5	21.3	21.9						13.4	13.2	13.3	4.70	4.50	4.60
	RWEYQ144PCYD	12 Tons	RWEYQ72PCYD	RWEYQ72PCYD		23.7	22.3	23.0						14.6	14.4	14.5	4.97	4.97	4.97
	RWEYQ168PCYD	14 Tons	RWEYQ84PCYD	RWEYQ84PCYD		23.1	21.3	22.2						12.7	12.7	12.7	4.38	4.38	4.38
	RWEYQ216PCYD	18 Tons	RWEYQ72PCYD	RWEYQ72PCYD	RWEYQ72PCYD	22.7	22.2	22.5						14.5	14.5	14.5	4.80	4.91	4.86
	RWEYQ252PCYD	21 Tons	RWEYQ84PCYD	RWEYQ84PCYD	RWEYQ84PCYD	21.5	20.0	20.8						12.8	12.8	12.8	4.48	4.48	4.48
VRV IV W-Series 460V Heat Recovery	RWEYQ72PCYD	6 Tons	RWEYQ72PCYD			24.1	22.3	23.2	17.8	19.2	18.5			14.0	14.0	14.0	4.89	4.78	
	RWEYQ84PCYD	7 Tons	RWEYQ84PCYD			22.5	21.3	21.9	17.0	17.7	17.3			13.4	13.2	13.3	4.70	4.50	
	RWEYQ144PCYD	12 Tons	RWEYQ72PCYD	RWEYQ72PCYD		23.7	22.3	23.0	17.7	19.3	18.5			14.6	14.4	14.5	4.97	4.97	
	RWEYQ168PCYD	14 Tons	RWEYQ84PCYD	RWEYQ84PCYD		23.1	21.3	22.2	17.0	17.8	17.4			12.7	12.7	12.7	4.38	4.38	
	RWEYQ216PCYD	18 Tons	RWEYQ72PCYD	RWEYQ72PCYD	RWEYQ72PCYD	22.2	20.9	21.5	17.8	17.4	17.6			13.3	13.4	13.3	4.80	4.91	
	RWEYQ252PCYD	21 Tons	RWEYQ84PCYD	RWEYQ84PCYD	RWEYQ84PCYD	21.0	19.3	20.1	15.6	15.8	15.7			12.8	12.4	12.6	4.48	4.48	
VRV IV W-Series 208/230V Heat Pump	RWEYQ72PCTJ	6 Tons	RWEYQ72PCTJ			24.1	22.3	23.2						14.0	14.0	14.0	4.89	4.78	
	RWEYQ84PCTJ	7 Tons	RWEYQ84PCTJ			22.5	21.3	21.9						13.4	13.2	13.3	4.70	4.50	4.60
	RWEYQ144PCTJ	12 Tons	RWEYQ72PCTJ	RWEYQ72PCTJ		23.7	22.3	23.0						14.6	14.4	14.5	4.97	4.97	4.97
	RWEYQ168PCTJ	14 Tons	RWEYQ84PCTJ	RWEYQ84PCTJ		23.1	21.3	22.2						12.7	12.7	12.7	4.38	4.38	4.38
	RWEYQ216PCTJ	18 Tons	RWEYQ72PCTJ	RWEYQ72PCTJ	RWEYQ72PCTJ	22.2	20.9	21.5						13.3	13.4	13.3	4.80	4.91	4.86
	RWEYQ252PCTJ	21 Tons	RWEYQ84PCTJ	RWEYQ84PCTJ	RWEYQ84PCTJ	21.0	19.3	20.1						12.8	12.4	12.6	4.48	4.48	4.48
VRV IV W-Series 208/230V Heat Recovery	RWEYQ72PCTJ	6 Tons	RWEYQ72PCTJ			24.1	22.3	23.2	17.8	19.2	18.5			14.0	14.0	14.0	4.89	4.78	
	RWEYQ84PCTJ	7 Tons	RWEYQ84PCTJ			22.5	21.3	21.9	17.0	17.7	17.3			13.4	13.2	13.3	4.70	4.50	
	RWEYQ144PCTJ	12 Tons	RWEYQ72PCTJ	RWEYQ72PCTJ		23.7	22.3	23.0	17.7	19.3	18.5			14.6	14.4	14.5	4.97	4.97	
	RWEYQ168PCTJ	14 Tons	RWEYQ84PCTJ	RWEYQ84PCTJ		23.1	21.3	22.2	17.0	17.8	17.4			12.7	12.7	12.7	4.38	4.38	
	RWEYQ216PCTJ	18 Tons	RWEYQ72PCTJ	RWEYQ72PCTJ	RWEYQ72PCTJ	22.2	20.9	21.5	17.8	17.4	17.6			13.3	13.4	13.3	4.80	4.91	
	RWEYQ252PCTJ	21 Tons	RWEYQ84PCTJ	RWEYQ84PCTJ	RWEYQ84PCTJ	21.0	19.3	20.1	15.6	15.8	15.7			12.8	12.4	12.6	4.48	4.48	

Certified efficiency data in accordance with ANSI/AHRI Standard 1230 2010, "Performance Rating of Variable Refrigerant Flow (VRF) Multi-Split Air Conditioning and Heat Pump Equipment" for the VRV IV W-Series. The VRV IV W-Series has been designed and optimized to meet or exceed the latest minimum efficiency requirements in 10 C.F.R. Part 431 as determined by the U.S. Department of Energy (DOE) and baseline efficiencies as defined by ASHRAE 90.1 2010. Systems under 65MBH are currently certified to AHRI 210/240. IEER ratings are as defined in ASHRAE 90.1 2010.

OUTDOOR UNITS

DETAILED STANDARD OPERATION RANGES FOR VRV IV W-SERIES CONDENSING UNITS

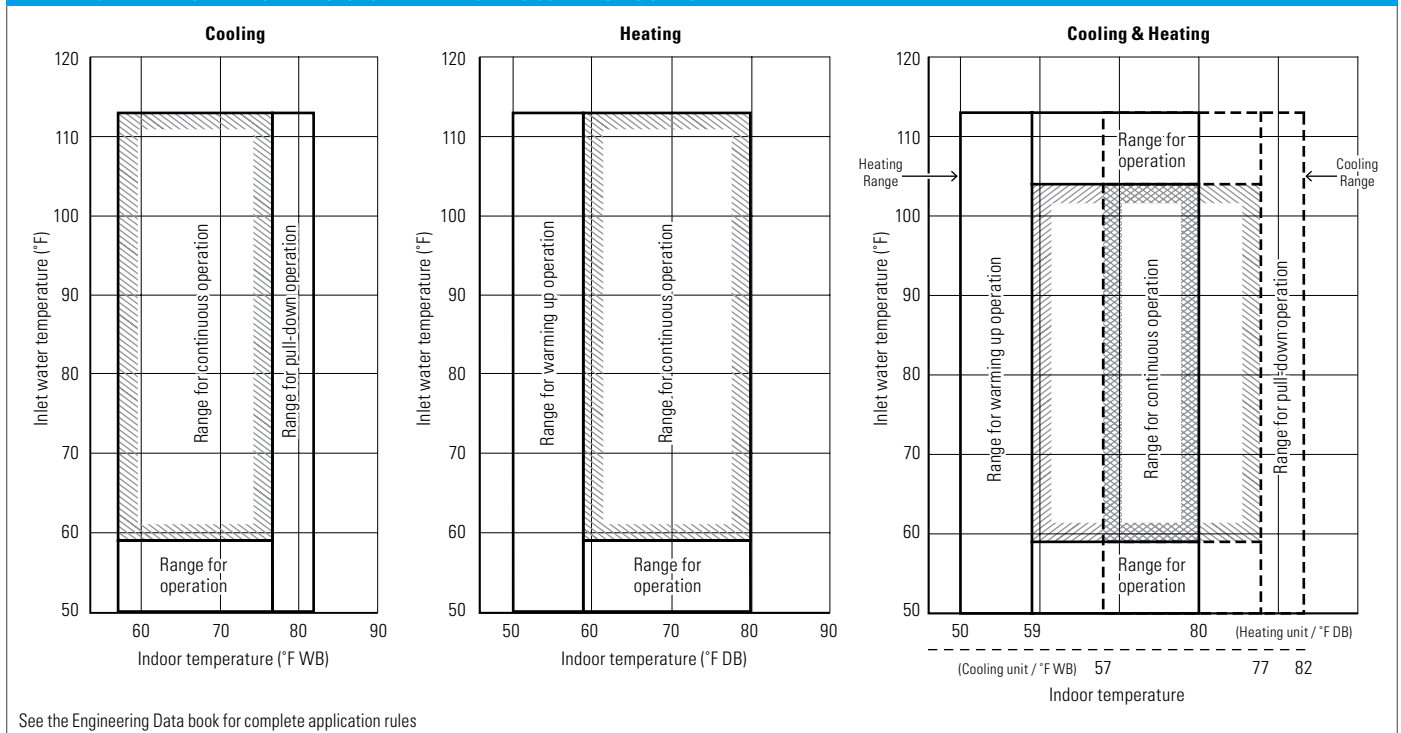

Single Module System 208-230V

A modular, energy-saving and reliable alternative to centralized equipment.

Features and Benefits

- Compact lightweight casing at 39-3/8" in height and 330 lbs. in weight
- Small condensers can be stacked for reduced installation space and increased usable square footage
- Larger single-system capacity and modular concept ensures wider application range for accommodating floor-by-floor loads of commercial buildings
- Can be applied to both geothermal and boiler/tower applications as standard with condenser water inlet temperature as low as 14°F in heating and 27°F in cooling is possible



RWEYQ-PCTJ

OUTDOOR UNITS

VRV IV W-SERIES UNIFIED HEAT PUMP AND HEAT RECOVERY			6 TON		7 TON	
Model	Name		RWEYQ72PCTJ		RWEYQ84PCTJ	
Performance	Rated Cooling Capacity ¹	BTU/h	64,000		80,000	
	Rated Heating Capacity ²	BTU/h	77,000		90,000	
	Power	V/ph/Hz	208-230/3/60			
	Sound Pressure Level @ 3 ft.	dB(A)	50		51	
Refrigerant Piping	System Configuration		Heat Pump	Heat Recovery	Heat Pump	Heat Recovery
	Liquid Pipe (Main Line)	in.	3/8			
	Suction Gas Pipe (Main Line)	in.	3/4		7/8	
	Discharge Gas Pipe (Main Line)	in.	N/A	5/8	N/A	3/4
	Vertical Pipe Length (if unit is below FCU)	ft.	164 (130)			
	Actual Pipe Length (Equivalent Length)	ft.	390 (459)			
	Total Pipe Length	ft.	980			
Connection Ratio	Standard Connectable Indoor Unit Ratio	%	50 - 130			
	Maximum Number of Indoor Units	Qty.	12		14	
Water Side (Standard)	BPHE Inlet Pipe (Female Thread)	in.	1-1/4 FPT			
	BPHE Outlet Pipe (Female Thread)	in.	1-1/4 FPT			
	Drain Pipe (Female Thread)	in.	1/2 FPS			
	Maximum System Water Pressure (BPHE)	psi	285			
	Standard Inlet Water Temperature Range	°F	50 - 113			
Water Side (Geothermal)	Recommended Inlet Water Flow Rate per Module (minimum) ³	gpm	16.4 - 39.5 (13.2)			
	Inlet Water Temperature Range Cooling ⁴	°F	27 (34 ⁵) - 113			
	Inlet Water Temperature Range Heating	°F	14 - 113			
Unit	Water Flow Rate	gpm	21 - 40			
	Weight	lbs.	330			
Electrical	Dimensions (H x W x D)	in.	39-3/8 x 30-3/4 x 21-11/16			
	Voltage Range (min - max)	V/ph/Hz	187 - 253			
	Maximum Overcurrent Protection (MOP)	A	30			
	Minimum Circuit Amps (MCA)	A	22.4			
	Compressor Rated Load Amps (RLA)	A	11.6		15.4	
Compressor	Compressor Type		Daikin G-Type Scroll			
	Compressor Set-Up		1 INV			
	Compressor Capacity Control	%	23 - 100			

¹ Indoor temp.: 80°FDB, 67°FWB/inlet water temp.: 85°F/
Equivalent piping length: 25 ft., level difference: 0 ft.

² Indoor temp.: 70°FDB, 60°FWB/inlet water temp.: 70°F/
Equivalent piping length: 25 ft., level difference: 0 ft.

³ Please note that a water strainer is required for each condensing unit model and now must be field supplied (strainer specification = 50 mesh).

⁴ Application rules apply below 48°F. Please contact your local Daikin office for design assistance and approval.

⁵ The minimum cooling EWT is 34°F when the condensing unit is located below the indoor units.

Double Module System 208-230V

A modular, energy-saving and reliable alternative to centralized equipment.

Features and Benefits

- Compact lightweight casing at 39-3/8" in height and 330 lbs. in weight per module
- Small condensers can be stacked for reduced installation space and increased usable square footage
- Larger single-system capacity and modular concept ensures wider application range for accommodating floor-by-floor loads of commercial buildings
- Can be applied to both geothermal and boiler/tower applications as standard with condenser water inlet temperature as low as 14°F in heating and 27°F in cooling is possible



RWEYQ-PCTJ

VRV IV W-SERIES UNIFIED HEAT PUMP AND HEAT RECOVERY			12 TON		14 TON	
Model	Name		RWEYQ144PCTJ		RWEYQ168PCTJ	
	Combination		2 x RWEYQ72PCTJ		2 x RWEYQ84PCTJ	
Performance	Rated Cooling Capacity ¹	BTU/h	138,000		160,000	
	Rated Heating Capacity ²	BTU/h	154,000		180,000	
	Power	V/ph/Hz	208-230/3/60			
	Sound Pressure Level @ 3 ft.	dB(A)	53		54	
Refrigerant Piping	System Configuration		Heat Pump	Heat Recovery	Heat Pump	Heat Recovery
	Liquid Pipe (Main Line)	in.	1/2		5/8	
	Suction Gas Pipe (Main Line)	in.	1-1/8			
	Discharge Gas Pipe (Main Line)	in.	N/A	7/8	N/A	7/8
	Vertical Pipe Length (if unit is below FCU)	ft.	164 (130)			
	Actual Pipe Length (Equivalent Length)	ft.	390 (459)			
	Total Pipe Length	ft.	980			
Connection Ratio	Standard Connectable Indoor Unit Ratio	%	50 - 130			
	Maximum Number of Indoor Units	Qty.	20			
Water Side (Standard)	BPHE Inlet Pipe (Female Thread)	in.	2 x (1-1/4 FPT)			
	BPHE Outlet Pipe (Female Thread)	in.	2 x (1-1/4 FPT)			
	Drain Pipe (Female Thread)	in.	2 x (1/2 FPS)			
	Maximum System Water Pressure (BPHE)	psi	285			
	Standard Inlet Water Temperature Range	°F	50 - 113			
Water Side (Geothermal)	Recommended Inlet Water Flow Rate per Module (minimum) ³	gpm	16.4 - 39.5 (13.2)			
	Inlet Water Temperature Range Cooling ⁴	°F	27 (34 ⁵) - 113			
	Inlet Water Temperature Range Heating	°F	14 - 113			
	Water Flow Rate	gpm	21 - 40			
Unit	Weight	lbs.	2 x 330			
	Dimensions (H x W x D)	in.	39-3/8 x (30-3/4 x 2) x 21-11/16			
Electrical	Voltage Range (min - max)	V/ph/Hz	187 - 253			
	Maximum Overcurrent Protection (MOP)	A	30 + 30			
	Minimum Circuit Amps (MCA)	A	22.4 + 22.4			
	Compressor Rated Load Amps (RLA)	A	11.6 + 11.6		15.4 + 15.4	
Compressor	Compressor Type		Daikin G-Type Scroll			
	Compressor Set-Up		1 INV + 1 INV			
	Compressor Capacity Control	%	11 - 100			

¹ Indoor temp.: 80°FDB, 67°FWB/inlet water temp.: 85°F/
Equivalent piping length : 25 ft., level difference : 0 ft.

² Indoor temp.: 70°FDB, 60°FWB/inlet water temp.: 70°F/
Equivalent piping length: 25 ft., level difference : 0 ft.

³ Please note that a water strainer is required for each condensing unit model and now must be field supplied (strainer specification = 50 mesh).

⁴ Application rules apply below 48°F. Please contact your local Daikin office for design assistance and approval.

⁵ The minimum cooling EWT is 34°F when the condensing unit is located below the indoor units.

Triple Module System 208-230V

A modular, energy-saving and reliable alternative to centralized equipment.

Features and Benefits

- Compact lightweight casing at 39-3/8" in height and 330 lbs. in weight per module
- Small condensers can be stacked for reduced installation space and increased usable square footage
- Larger single-system capacity and modular concept ensures wider application range for accommodating floor-by-floor loads of commercial buildings
- Standard VRV IV W-Series systems can operate with condenser water temperatures down to 50°F but this can be extended to 14°F in heating



RWEYQ-PCTJ

VRV IV W-SERIES UNIFIED HEAT PUMP AND HEAT RECOVERY			18 TON		21 TON	
Model	Name		RWEYQ216PCTJ		RWEYQ252PCTJ	
	Combination		3 x RWEYQ72PCTJ		3 x RWEYQ84PCTJ	
Performance	Rated Cooling Capacity ¹	BTU/h	206,000		240,000	
	Rated Heating Capacity ²	BTU/h	232,000		270,500	
	Power	V/ph/Hz	208-230/3/60			
	Sound Pressure Level @ 3 ft.	dB(A)	56		57	
Refrigerant Piping	System Configuration		Heat Pump	Heat Recovery	Heat Pump	Heat Recovery
	Liquid Pipe (Main Line)	in.	5/8		3/4	
	Suction Gas Pipe (Main Line)	in.	1-3/8			
	Discharge Gas Pipe (Main Line)	in.	N/A	1-1/8	N/A	1-1/8
	Vertical Pipe Length (if unit is below FCU)	ft.	164 (130)			
	Actual Pipe Length (Equivalent Length)	ft.	390 (459)			
	Total Pipe Length	ft.	980			
Connection Ratio	Standard Connectable Indoor Unit Ratio	%	50 - 130			
	Maximum Number of Indoor Units	Qty.	22			
Water Side (Standard)	BPHE Inlet Pipe (Female Thread)	in.	3 x (1-1/4 FPT)			
	BPHE Outlet Pipe (Female Thread)	in.	3 x (1-1/4 FPT)			
	Drain Pipe (Female Thread)	in.	3 x (1/2 FPS)			
	Maximum System Water Pressure (BPHE)	psi	285			
	Standard Inlet Water Temperature Range	°F	50 - 113			
Water Side (Geothermal)	Recommended Inlet Water Flow Rate per Module (minimum) ³	gpm	16.4 ~ 39.5 (13.2)			
	Inlet Water Temperature Range Cooling ⁴	°F	27 (34 ⁵) - 113			
	Inlet Water Temperature Range Heating	°F	14 - 113			
Unit	Water Flow Rate	gpm	21 - 40			
	Weight	lbs.	3 x 330			
	Dimensions (H x W x D)	in.	39-3/8 x (30-3/4 x 3) x 21-11/16			
Electrical	Voltage Range (min - max)	V/ph/Hz	187 - 253			
	Maximum Overcurrent Protection (MOP)	A	30 + 30 + 30			
	Minimum Circuit Amps (MCA)	A	22.4 + 22.4 + 22.4			
	Compressor Rated Load Amps (RLA)	A	11.6 + 11.6 + 11.6		15.4 + 15.4 + 15.4	
Compressor	Compressor Type		Daikin G-Type Scroll			
	Compressor Set-Up		1 INV + 1 INV + 1 INV			
	Compressor Capacity Control	%	8 - 100			

¹ Indoor temp.: 80°FDB, 67°FWB/inlet water temp.: 85°F/ Equivalent piping length: 25 ft., level difference: 0 ft.

² Indoor temp.: 70°FDB, 60°FWB/inlet water temp.: 70°F/ Equivalent piping length: 25 ft., level difference: 0 ft.

³ Please note that a water strainer is required for each condensing unit model and now must be field supplied (strainer specification = 50 mesh).

⁴ Application rules apply below 48°F. Please contact your local Daikin office for design assistance and approval.

⁵ The minimum cooling EWT is 34°F when the condensing unit is located below the indoor units.

OUTDOOR UNITS

Single Module System 460V

A modular, energy-saving and reliable alternative to centralized equipment.

Features and Benefits

- Compact lightweight casing at 39-3/8" in height and 343 lbs. in weight
- Small condensers can be stacked for reduced installation space and increased usable square footage
- Larger single-system capacity and modular concept ensures wider application range for accommodating floor-by-floor loads of commercial buildings
- Standard VRV IV W-Series systems can operate with condenser water temperatures down to 50°F but this can be extended to 14°F in heating



RWEYQ-PCYD

VRV IV W-SERIES UNIFIED HEAT PUMP AND HEAT RECOVERY			6 TONS		7 TONS	
Model	Name		RWEYQ72PCYD		RWEYQ84PCYD	
Performance	Rated Cooling Capacity ¹	BTU/h	69,000		80,000	
	Rated Heating Capacity ²	BTU/h	77,000		90,000	
	Power	V/ph/Hz	460/3/60			
	Sound Pressure Level @ 3 ft.	dB(A)	50		51	
Refrigerant Piping	System Configuration		Heat Pump	Heat Recovery	Heat Pump	Heat Recovery
	Liquid Pipe (Main Line)	in.	3/8			
	Suction Gas Pipe (Main Line)	in.	3/4		7/8	
	Discharge Gas Pipe (Main Line)	in.	N/A	5/8	N/A	3/4
	Vertical Pipe Length (if unit is below FCU)	ft.	164 (130)			
	Actual Pipe Length (Equivalent Length)	ft.	390 (459)			
	Total Pipe Length	ft.	980			
Connection Ratio	Standard Connectable Indoor Unit Ratio	%	50 - 130			
	Maximum Number of Indoor Units	Qty.	12			
Water Side (Standard)	BPHE Inlet Pipe (Female Thread)	in.	1-1/4 FPT			
	BPHE Outlet Pipe (Female Thread)	in.	1-1/4 FPT			
	Drain Pipe (Female Thread)	in.	1/2 FPS			
	Maximum System Water Pressure (BPHE)	psi	285			
	Standard Inlet Water Temperature Range	°F	50 - 113			
Water Side (Geothermal)	Recommended Inlet Water Flow Rate per Module (minimum) ³	gpm	16.4 - 39.5 (13.2)			
	Inlet Water Temperature Range Cooling ⁴	°F	27 (34 ⁵) - 113			
	Inlet Water Temperature Range Heating	°F	14 - 113			
	Water Flow Rate	gpm	21 - 40			
Unit	Weight	lbs.	343			
	Dimensions (H x W x D)	in.	39-3/8 x 30-3/4 x 21-11/16			
Electrical	Voltage Range (min - max)	V/ph/Hz	414 - 506			
	Maximum Overcurrent Protection (MOP)	A	15			
	Minimum Circuit Amps (MCA)	A	10.2			
	Compressor Rated Load Amps (RLA)	A	5.3	7.0		
Compressor	Compressor Type		Daikin G-Type Scroll			
	Compressor Set-Up		1 INV			
	Compressor Capacity Control	%	23 - 100			

¹ Indoor temp.: 80°FDB, 67°FWB/inlet water temp.: 85°F/ Equivalent piping length: 25 ft., level difference: 0 ft.

² Indoor temp.: 70°FDB, 60°FWB/inlet water temp.: 70°F/ Equivalent piping length: 25 ft., level difference: 0 ft.

³ Please note that a water strainer is required for each condensing unit model and now must be field supplied (strainer specification = 50 mesh).

⁴ Application rules apply below 48°F. Please contact your local Daikin office for design assistance and approval.

⁵ The minimum cooling EWT is 34°F when the condensing unit is located below the indoor units.

OUTDOOR UNITS

Double Module System 460V

A modular, energy-saving and reliable alternative to centralized equipment.

Features and Benefits

- Compact lightweight casing at 39-3/8" in height and 343 lbs. in weight per module
- Small condensers can be stacked for reduced installation space and increased usable square footage
- Larger single-system capacity and modular concept ensures wider application range for accommodating floor-by-floor loads of commercial buildings
- Standard VRV IV W-Series systems can operate with condenser water temperatures down to 50°F but this can be extended to 14°F in heating



RWEQY-PCYD

OUTDOOR UNITS

VRV IV W-SERIES UNIFIED HEAT PUMP AND HEAT RECOVERY			12 TON		14 TON	
Model	Name		RWEQY144PCYD		RWEQY168PCYD	
	Combination		2 x RWEQY72PCYD		2 x RWEQY84PCYD	
Performance	Rated Cooling Capacity ¹	BTU/h	138,000		160,000	
	Rated Heating Capacity ²	BTU/h	154,000		180,000	
	Power	V/ph/Hz	460/3/60			
	Sound Pressure Level @ 3 ft.	dB(A)	53		54	
Refrigerant Piping	System Configuration		Heat Pump	Heat Recovery	Heat Pump	Heat Recovery
	Liquid Pipe (Main Line)	in.	1/2		5/8	
	Suction Gas Pipe (Main Line)	in.	1-1/8			
	Discharge Gas Pipe (Main Line)	in.	N/A	7/8	N/A	7/8
	Vertical Pipe Length (if unit is below FCU)	ft.	164 (130)			
	Actual Pipe Length (Equivalent Length)	ft.	390 (459)			
	Total Pipe Length	ft.	980			
Connection Ratio	Standard Connectable Indoor Unit Ratio	%	50 - 130			
	Maximum Number of Indoor Units	Qty.	20			
Water Side (Standard)	BPHE Inlet Pipe (Female Thread)	in.	2 x (1-1/4 FPT)			
	BPHE Outlet Pipe (Female Thread)	in.	2 x (1-1/4 FPT)			
	Drain Pipe (Female Thread)	in.	2 x (1/2 FPS)			
	Maximum System Water Pressure (BPHE)	psi	285			
	Standard Inlet Water Temperature Range	°F	50 - 113			
Water Side (Geothermal)	Recommended Inlet Water Flow Rate per Module (minimum) ³	gpm	16.4 - 39.5 (13.2)			
	Inlet Water Temperature Range Cooling ⁴	°F	27 (34 ⁵) - 113			
	Inlet Water Temperature Range Heating	°F	14 - 113			
	Water Flow Rate	gpm	21 - 40			
Unit	Weight	lbs.	2 x 343			
	Dimensions (H x W x D)	in.	39-3/8 x (30-3/4 x 2) x 21-11/16			
Electrical	Voltage Range (min - max)	V/ph/Hz	414 - 506			
	Maximum Overcurrent Protection (MOP)	A	15 + 15			
	Minimum Circuit Amps (MCA)	A	10.2 + 10.2			
	Compressor Rated Load Amps (RLA)	A	5.3 + 5.3		7.0 + 7.0	
Compressor	Compressor Type		Daikin G-Type Scroll			
	Compressor Set-Up		1 INV + 1 INV			
	Compressor Capacity Control	%	11 - 100			

¹ Indoor temp.: 80°FDB, 67°FWB/inlet water temp.: 85°F/ Equivalent piping length: 25 ft., level difference: 0 ft.

² Indoor temp.: 70°FDB, 60°FWB/inlet water temp.: 70°F/ Equivalent piping length: 25 ft., level difference: 0 ft.

³ Please note that a water strainer is required for each condensing unit model and now must be field supplied (strainer specification = 50 mesh).

⁴ Application rules apply below 48°F. Please contact your local Daikin office for design assistance and approval.

⁵ The minimum cooling EWT is 34°F when the condensing unit is located below the indoor units.

Triple Module System 460V

A modular, energy-saving and reliable alternative to centralized equipment.

Features and Benefits

- Compact lightweight casing at 39-3/8" in height and 343 lbs. in weight per module
- Small condensers can be stacked for reduced installation space and increased usable square footage
- Larger single-system capacity and modular concept ensures wider application range for accommodating floor-by-floor loads of commercial buildings
- Standard VRV IV W-Series systems can operate with condenser water temperatures down to 50°F but this can be extended to 14°F in heating



RWEYQ-PCYD

VRV IV W-SERIES UNIFIED HEAT PUMP AND HEAT RECOVERY			18 TONS		21 TONS	
Model	Name		RWEYQ216PCYD		RWEYQ252PCYD	
	Combination		3 x RWEYQ72PCYD		3 x RWEYQ84PCYD	
Performance	Rated Cooling Capacity ¹	BTU/h	206,000		240,000	
	Rated Heating Capacity ²	BTU/h	232,000		270,500	
	Power	V/ph/Hz	460/3/60			
	Sound Pressure Level @ 3 ft.	dB(A)	56		57	
Refrigerant Piping	System Configuration		Heat Pump	Heat Recovery	Heat Pump	Heat Recovery
	Liquid Pipe (Main Line)	in.	5/8		3/4	
	Suction Gas Pipe (Main Line)	in.	1-3/4			
	Discharge Gas Pipe (Main Line)	in.	N/A	1-1/8	N/A	1-1/8
	Vertical Pipe Length (if unit is below FCU)	ft.	164 (130)			
	Actual Pipe Length (Equivalent Length)	ft.	390 (459)			
	Total Pipe Length	ft.	980			
Connection Ratio	Standard Connectable Indoor Unit Ratio	%	50 - 130			
	Maximum Number of Indoor Units	Qty.	22			
Water Side (Standard)	BPHE Inlet Pipe (Female Thread)	in.	3 x (1-1/4 FPT)			
	BPHE Outlet Pipe (Female Thread)	in.	3 x (1-1/4 FPT)			
	Drain Pipe (Female Thread)	in.	3 x (1/2 FPS)			
	Maximum System Water Pressure (BPHE)	psi	285			
	Standard Inlet Water Temperature Range	°F	50 - 113			
Water Side (Geothermal)	Recommended Inlet Water Flow Rate per Module (minimum) ³	gpm	16.4 - 39.5 (13.2)			
	Inlet Water Temperature Range Cooling ⁴	°F	27 (34 ⁵) - 113			
	Inlet Water Temperature Range Heating	°F	14 - 113			
	Water Flow Rate	gpm	21 - 40			
Unit	Weight	lbs.	3 x 343			
	Dimensions (H x W x D)	in.	39-3/8 x (30-3/4 x 3) x 21-11/16			
Electrical	Voltage Range (min - max)	V/ph/Hz	414 - 506			
	Maximum Overcurrent Protection (MOP)	A	15 + 15 + 15			
	Minimum Circuit Amps (MCA)	A	10.2 + 10.2 + 10.2			
	Compressor Rated Load Amps (RLA)	A	5.3 + 5.3 + 5.3		7.0 + 7.0 + 7.0	
Compressor	Compressor Type		Daikin G-Type Scroll			
	Compressor Set-Up		1 INV + 1 INV + 1 INV			
	Compressor Capacity Control	%	8 - 100			

¹ Indoor temp.: 80°FDB, 67°FWB/inlet water temp.: 85°F/ Equivalent piping length: 25 ft., level difference: 0 ft.

² Indoor temp.: 70°FDB, 60°FWB/inlet water temp.: 70°F/ Equivalent piping length: 25 ft., level difference: 0 ft.

³ Please note that a water strainer is required for each condensing unit model and now must be field supplied (strainer specification = 50 mesh).

⁴ Application rules apply below 48°F. Please contact your local Daikin office for design assistance and approval.

⁵ The minimum cooling EWT is 34°F when the condensing unit is located below the indoor units.

OUTDOOR UNITS

VRV III-S

Heat Pump 208-230V

VRV III-S systems are equipped with built-in intelligence which provide independent zoning control to help maximize flexibility and energy savings. With the ability to connect up to eight indoor units to one outdoor unit, the space saving VRV III-S system is ideal for most light commercial and residential applications.

Light Commercial

A highly efficient solution for small commercial applications, the VRV III-S provides cooling and heating for up to 8 zones. With many different indoor unit options to choose from, systems can be paired with a mix of ducted and duct-free indoor units for a customizable system for almost any application.

Designed for flexibility and versatility, the VRV III-S system provides long piping lengths (up to 1000 ft. actual piping length one way), making it an accommodating and space-saving solution for almost any floor layout.

Features and Benefits

- Single phase technology
- Smaller capacity for precise temperature control
- Space saving design and flexible indoor unit option offer quick and easy installation
- Superior energy efficiency, especially under part load conditions
- Soft sound levels for comfort
- Single supplier reliability
- Straightforward maintenance and service with self-diagnostic functions



VRV III-S

Residential

VRV III-S provides an intelligent alternative for both renovated and new construction homes. Connecting up to eight zones on a single outdoor unit, this system provides design flexibility in a compact, space-saving design.

Indoor units offer speed control with quiet operating sound levels as low as 28 dB(A) with outdoor units having built-in noise reducing features. Activate the night set mode feature and operating sounds progressively reduce 3 B(A) for quieter and gentler cooler or heating.



CERTIFIED PERFORMANCE DATA

Model Number	Indoor Units Combination	Nominal Cooling Capacity (BTU/h)	EER 95F	SEER	Nominal Heating Capacity (BTU/h)	Heating COP @ 47 °F	Low Heating Capacity (BTU/h)	Heating COP @ 17 °F	HSPF
RXYMQ36PVJU	Ducted Indoor Units	36,000	9.9	14	42,000	2.90	29,500	2.10	8.4
	Non-Ducted Indoor Units	36,000	11.5	14.9	42,000	2.80	26,000	2.00	8.2
	Mixed Ducted and Non-Ducted Indoor Units	36,000	10.7	14.45	42,000	2.85	27,750	2.05	8.3
RXYMQ48PVJU	Ducted Indoor Units	47,500	9	14	52,500	2.70	36,500	2.00	8.8
	Non-Ducted Indoor Units	47,500	9	15.1	52,500	2.60	33,000	2.00	9.1
	Mixed Ducted and Non-Ducted Indoor Units	47,500	9	14.55	52,500	2.65	34,750	2.00	8.95

VRV III-S 208-230V HEAT PUMP

Model	Name		RXYMQ36PVJU	RXYMQ48PVJU
Performance	Rated Cooling Capacity	BTU/h	36,000	47,500
	Rated Heating Capacity	BTU/hw	42,000	52,500
	Operating Range - Cooling	°F DB	23 - 115	
	Operating Range - Heating	°F DB/°F WB	0 - 64 / -5 - 60	
	Power	V/ph/Hz	208-230/1/60	
	Sound Pressure Level @ 3 ft.	dB(A)	58	
Refrigerant Piping	Refrigerant Type and Quantity	(lbs.)	R-410A (8.8)	
	Liquid Pipe (Main Line)	in.	3/8 (Flare)	
	Suction Gas Pipe (Main Line)	in.	5/8 (Flare)	
	Vertical Pipe Length	ft.	164	
	Actual Pipe Length (Equivalent Length)	ft.	492	
	Total Piping Length	ft.	984	
Connection Ratio	Connectable Indoor Unit Ratio	%	50 - 130%	
	Number of Indoor Units	Qty.	6	
Unit	Weight	lbs.	283	
	Dimensions (H x W x D)	in.	52-15/16 x 35-7/16 x 12-5/8	
Fan	Airflow	CFM	3,740	
	Fan Motor Output and Quantity	kW (Qty.)	0.07 (2)	
Electrical	Maximum Overcurrent Protection (MOP)	A	30.0	
	Minimum Circuit Amps (MCA)	A	27.0	
	Compressor Rated Load Amps (RLA)	A	17.6	23.3
Compressor	Compressor Type		Daikin G-Type Scroll	
	Compressor Set-Up		1 INV	
	Compressor Capacity Control	%	29 - 100	

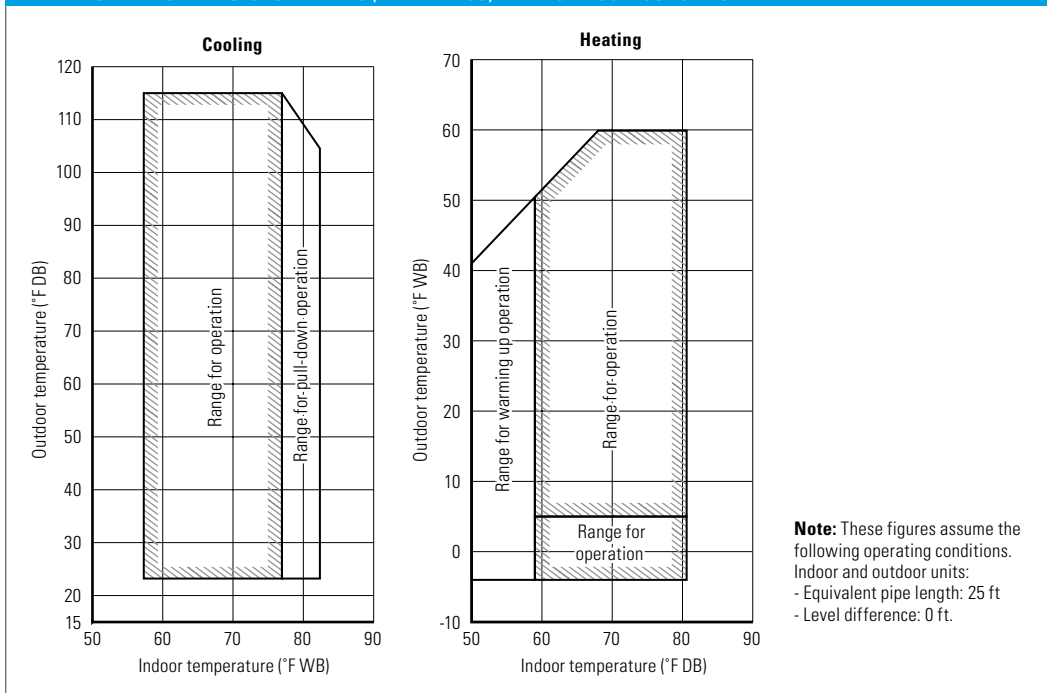
OUTDOOR UNITS
DETAILED OPERATION RANGES FOR VRV III-S (RXYMQ-PVJU) HEAT PUMP OUTDOOR UNITS

Installation Space

VRV IV

Installation Space Examples

- The installation space requirement shown in the figure is a reference for cooling.
- During installation, install the units using the most appropriate of the patterns shown in the figure for the location in question, taking into consideration human traffic and wind.
- If the number of units installed is more than that shown in the pattern in the figure, install the units so that there is no air short circuiting.
- Consider the space needed for the refrigerant piping when installing the units, as determined by local codes.
- If the space requirements in the figure do not apply, contact your contractor or Daikin directly.

For single unit installation

< Pattern 1 >

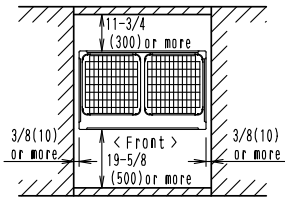

< Pattern 2 >

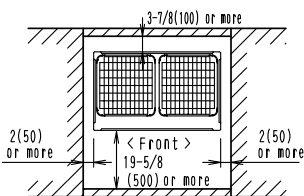

< Pattern 3 >

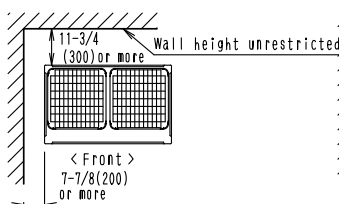

For installation in rows

< Pattern 1 >

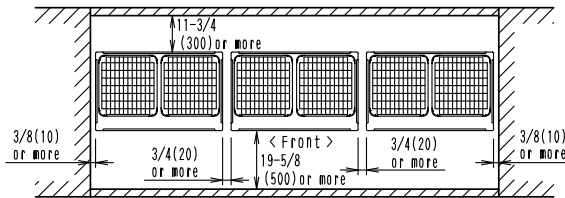

< Pattern 2 >

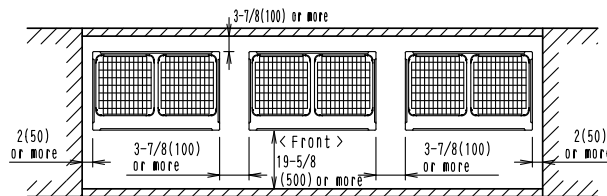

< Pattern 3 >

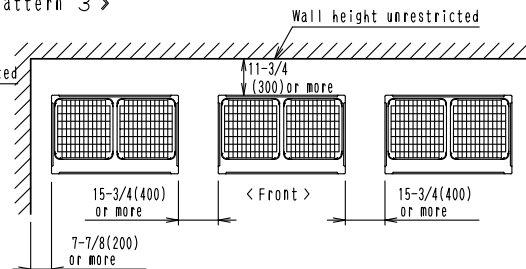

For centralized group layout

< Pattern 1 >

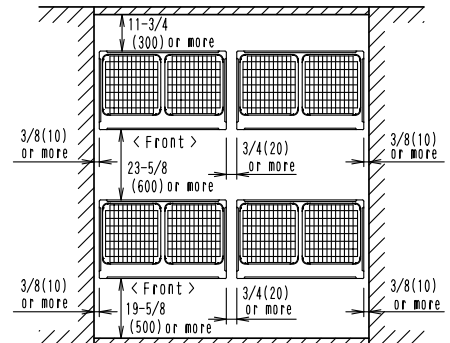

< Pattern 2 >

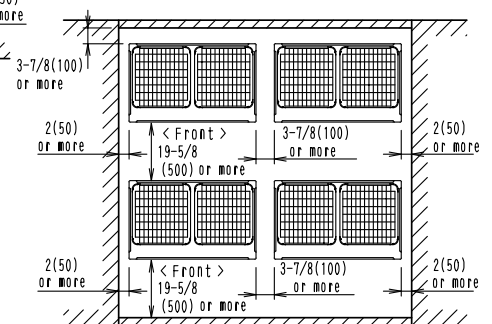

OUTDOOR UNITS

VRV IV

Notes

1. Heights of walls in case of Patterns 1 and 2:
Front: 59in
Suction side: 19-5/8in
Side: Height unrestricted.
Installation space shown in this drawing is based on the cooling operation at 95°F outdoor air temperature. When the design outdoor temperature exceeds 95°F or the load exceeds maximum ability because of much generation load of heat in all outdoor unit, take the suction-side space more broadly than the space shown in this drawing.
2. If the above wall heights are exceeded then $h2/2$ and $h1/2$ should be added to the front and suction side service spaces respectively as shown in the figure.

3. When installing, the units most appropriate pattern should be selected in order to obtain the best fit in the space available, always bearing in mind the need to leave enough space for a person to pass between the units and wall and for the air to circulate freely.
4. The units should be installed to leave sufficient space at the front for the field refrigerant piping work to be carried out comfortably.

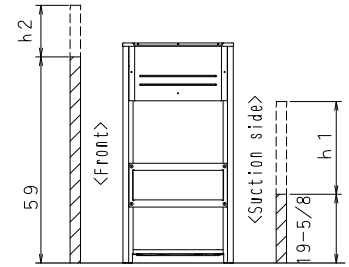

Installation Space

VRV III

For single unit installation

For installation in rows

For centralized group layout

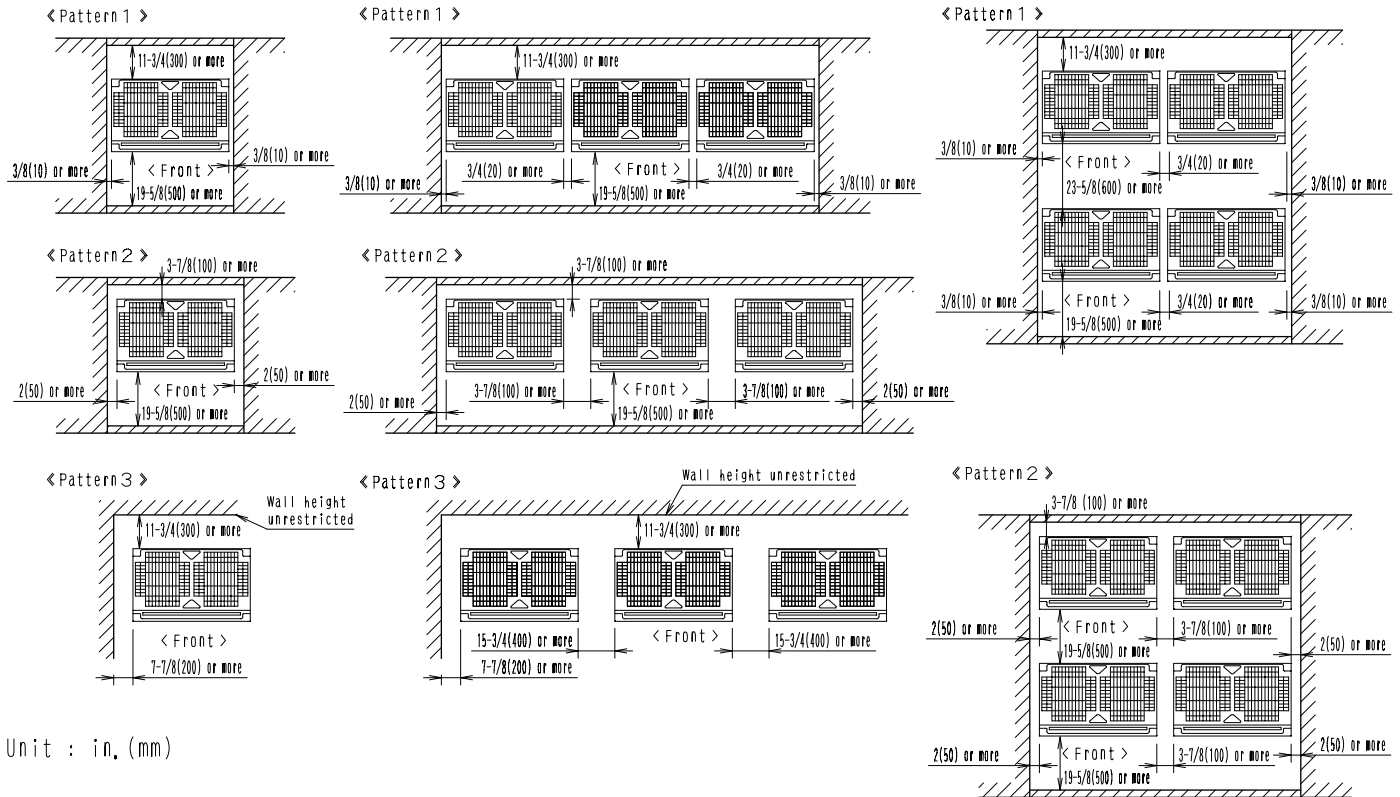

Unit : in. (mm)

Notes

1. Heights of walls in case of Patterns 1 and 2:

Front: 59in.

Suction side: 19-5/8in

Side: Height unrestricted.

Installation space shown in above are based on the cooling operation at 95°FDB outdoor air temperature.

The suction side space must be extended in the following case.

- When the design outdoor temperature exceeds 95°FDB.
- When the heat loads are large and exceed maximum operating loads for all outdoor units.

2. When the wall heights exceed above, add "h2" /2 and "h1" /2 to the front and suction service spaces respectively. (See right figure for "h2" and "h1".)

3. When installing units, the most appropriate pattern from those shown above should be selected.

- a person to pass between the units and surrounding walls.
- the air to circulate freely.
- The possibility of short circuiting should be evaluated when installing more units that those shown in the patterns above.

4. Sufficient space should be provided in front of the units for refrigerant piping installation and servicing.

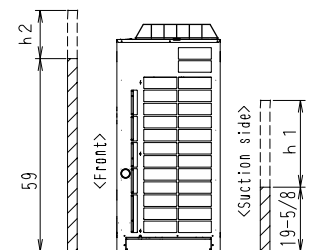

VRV IV

W Series Water Cooled System

1. In case of a single installation [inch.]
2. In case of multiple unit installation [inch.]
3. Top view
4. Side view
5. Condensing unit
6. Service Space (front side)
7. Service Space (back side)
8. Space for installing water piping must be ample enough to remove the front panel.

9. Ventilation space above the area () of the condensing unit.

10. Secure spaces in the front, back, and top sides as same as the case of single installation.

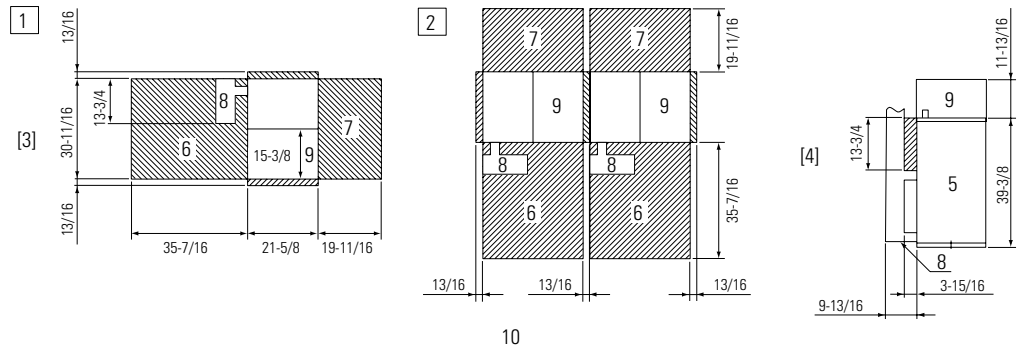

VRV III-S

In case of series installation, some space between the units is needed for wiring with conduit and servicing.

1. Where there is an obstacle on the suction side:

- (a) No obstacle above
 - (1) Stand alone installation
 - Obstacle on the suction side only
 - Obstacle on both sides

2. Where there is an obstacle on the discharge side:

- (a) No obstacle above
 - (1) Stand alone installation

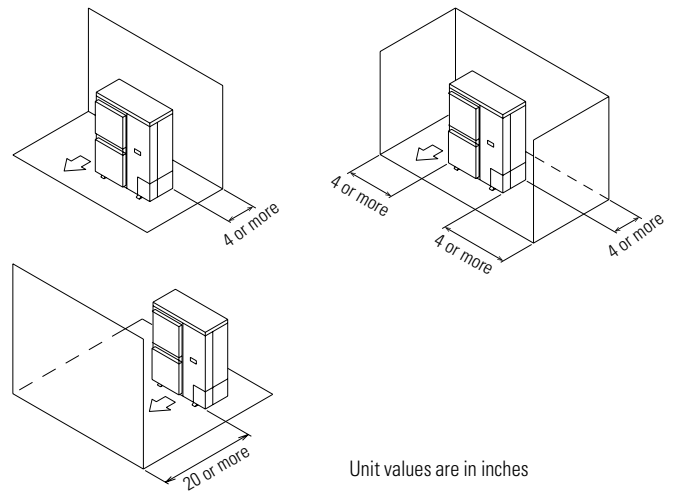

OUTDOOR UNITS

Piping length

The long piping length provides more design flexibility, which can match even large-sized buildings.

Air-cooled system piping length

For connection of only VRV indoor units

	VRV III PC & VRV IV	VRV III-S
Max. actual piping length	541 ft.	492 ft.
Max. equivalent piping length	623 ft.	580 ft.
Max. total piping length	3281 ft.	1000 ft.
Max. level difference between the outdoor units and the indoor units	295 ft.[†]	164 ft.[†]
Max. level difference between the indoor units	100 ft.[*]	49 ft.
Max. distance from 1st refrigerant branch joint	295 ft.	131 ft.

Colors in the diagram above are merely for identifying pipes referenced with symbols such as (a).

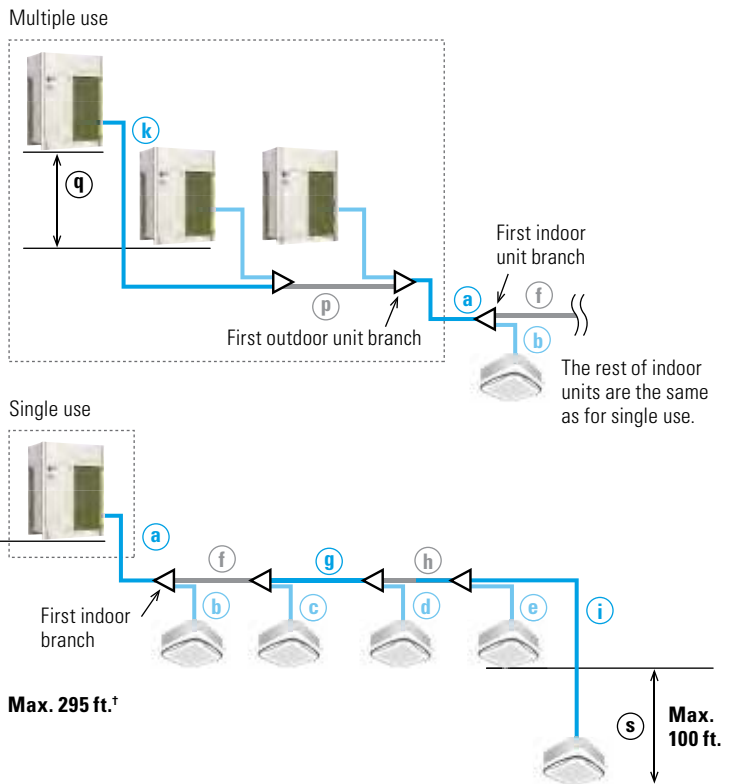

Piping for VRV IV, VRV III PC and VRV III-S

		ACTUAL PIPING LENGTH	EXAMPLE	EQUIVALENT PIPING LENGTH
		VRV-IV / VRV-III-S		VRV-IV / VRV-III-S
Maximum allowable piping length	Refrigerant piping length	541 ft. / 492 ft.	a+f+g+h+i	623 ft / 580 ft.
	Total piping length	3281 ft. / 1000 ft.	a+b+c+d+e+f+g+h+i	—
	Between the first indoor unit branch and the farthest indoor unit	295 ft. / 131 ft.*	f+g+h+i	—
	Between the outdoor unit branch and the last outdoor unit	33 ft. / n/a	k+p	43 ft / n/a

		LEVEL DIFFERENCE	EXAMPLE	
		VRV-IV / VRV-III-S		
Maximum allowable level difference	Between the outdoor units (multiple use on the same circuit)	16 ft. / n/a	q	
	Between the indoor units	98 ft. / 49	s	
	Between the outdoor units and the indoor units	If the outdoor unit is above	295 ft. / 164	r
		If the outdoor unit is below	295 ft. / 164	r

[†] No special requirements up to 131 ft. The maximum actual piping length can be 295 ft., depending on conditions. Various conditions and requirements have to be met to allow utilization of 295 ft. piping length. Be sure to refer to the Engineering Data Book for details of these conditions and requirements.

^{*} When level differences are 164 ft. or more, the diameter of the main liquid piping size must be increased and connection ratio must be 80% to 130%. If the outdoor unit is above the indoor unit, a dedicated setting on the outdoor unit is required. Refer to the Engineering Data Book and contact your local dealer for more information.

• 100 ft. is supported for VRV-IV. For VRV-III PC, the limit is 49 ft.

Water-cooled system piping length

Considerable flexibility is available within the refrigerant circuit since up to 980 ft. actual piping length and 164 ft. (if the VRV IV W-Series condensing unit is above the indoor unit) in

height can exist between the VRV IV W-Series condensing units and indoor units. Water piping does not intrude in the occupied spaces, so there are no potential leakage problems.

For connection of only VRV indoor units

Actual piping length between the VRV IV W-Series and indoor units: 390 ft. (equivalent piping length: 459 ft.)

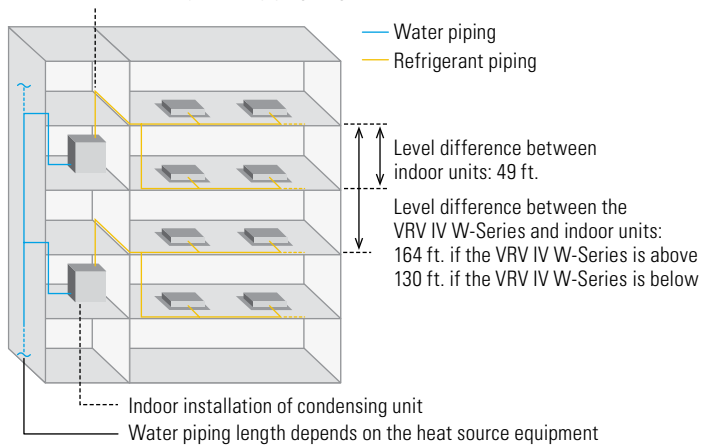

REFRIGERANT PIPING LIMITATIONS	LIMITATIONS
Linear piping between condensing unit and furthest located fan coil unit (equivalent), ft.	390 (459)
Total "one-way" piping in the complete piping network, ft.	980
Vertical (height) separation between the condensing unit and the fan coil units (if condensing unit is below)*, ft.	164 (130)
Vertical (height) separation between fan coil units, ft.	49
Linear piping between 1st REFNET and furthest located fan coil unit, ft.	130

* For geothermal applications, if the condenser is lower than the indoor units, the maximum vertical separation is 65 ft.

OUTDOOR UNITS



Branch Selector Boxes

NEW Branch Selector Boxes for Heat Recovery Systems

Providing flexibility and minimizing mechanical and electrical installation costs, Daikin's branch selector boxes are ideal for spaces that require individual heating and cooling control.

- Extended range of product offerings with 1, 4, 6, 8, 10 and 12 port options
- No drain or condensate consideration required
- Unlimited number of unused ports per box or system
- Reduced electrical and mechanical installation costs
- Ultimate flexibility – Choose multi-port or single-port styles to customize your design
- Up to 72% reduction in footprint, as compared to previous generation models
- Up to 17% lower sound levels compared to current VRV III models
- Up to 65% reduction in weight, as compared to previous generation models



BSQ36TVJ, BSQ60TVJ, & BSQ96TVJ Single Port



BS4Q54TVJ



BS6Q54TVJ



BS10Q54TVJ

Branch Selector Boxes Compatibility

Single-Port and Multi-Port Branch Selector Boxes BS-TVJ Series are compatible with VRV IV, VRV IV W-Series and VRV III REYQ-PC Series.

OUTDOOR UNITS

Daikin's branch selector boxes are ideal for spaces that require individual heating and cooling control.

TECHNICAL DATA FOR MULTI-PORT BRANCH SELECTOR BOXES											
Model	BS4Q54TVJ		BS6Q54TVJ		BS8Q54TVJ		BS10Q54TVJ		BS12Q54TVJ		
Number of branches	4		6		8		10		12		
Maximum capacity index per branch					54						
Maximum total capacity index	144		216				290				
Maximum connectable indoor units per branch					5						
Connecting Pipes	IU	Liquid	in.		Ø1/4, Ø3/8						
		Gas	in.		Ø1/2, Ø5/8						
	IU	Liquid	in.		Ø3/8		Ø1/2		Ø5/8		
		Suction Gas	in.		Ø7/8		Ø1-1/8				
		HP/LP Gas	in.		Ø3/4		Ø1-1/8				
Electrical	Power Supply	ph/V/Hz		1/208-230/60							
	Maximum Overcurrent Protection, MOP	A		15							
	Minimum Circuit Amps, MCA	A		0.6		0.8		1		1.2	
Mass (Weight)	lbs		49		68		73		101		
Dimensions (H x W x D)	in.		11-3/4 x 14-9/16 x 18-15/16		11-3/4 x 22-13/16 x 18-15/16		11-3/4 x 32-5/16 x 18-15/16				

MULTI-PORT BRANCH SELECTOR BOX INSTALLATION SPACE

MINIMUM CLEARANCE	BS4Q54TVJ	BS6Q54TVJ	BS8Q54TVJ	BS10Q54TVJ	BS12Q54TVJ
A	in.	20			
B	in.	11-3/4			

TECHNICAL DATA FOR SINGLE-PORT BRANCH SELECTOR BOXES							
Model	BSQ36TVJ		BSQ60TVJ		BSQ96TVJ		
Number of branches	1		1		1		
Maximum capacity index	36		60		96		
Maximum connectable indoor units	4		8		8		
Connecting Pipes	IU	Liquid	in.		Ø3/8		
		Gas	in.		Ø5/8		
	IU	Liquid	in.		Ø3/8		
		Suction Gas	in.		Ø5/8		
		HP/LP Gas	in.		Ø1/2		
Electrical	Power Supply	ph/V/Hz		1/208-230/60			
	Maximum Overcurrent Protection, MOP	A		15			
	Minimum Circuit Amps, MCA	A		0.1			
Mass (Weight)	lbs		27		33		
Dimensions (H x W x D)	in.		8-1/8 x 15-1/4 x 12-13/16				

SINGLE-PORT BRANCH SELECTOR BOX INSTALLATION SPACE

MINIMUM CLEARANCE	BSQ36TVJ	BSQ60TVJ	BSQ96TVJ	
A	in.	10	10	12
B	in.	10	10	12
C	in.	-	13-3/4	15-3/4
D	in.	12	13-3/4	15-3/4
E	in.	12	12	11-13/16

For additional technical information and all equipment installation and application limitations please refer to the specific Engineering Data Books.

OUTDOOR UNITS

REFNET pipe joints

REFNET

REFNET joints distribute correct flow of refrigerant in every branch of the piping network.



REFNET Joint



REFNET Header

VRV IV Heat Pump

OPTIONAL ACCESSORIES		RXYQ72T RXYQ96T	RXYQ120T RXYQ144T RXYQ168T	RXYQ192T RXYQ216T RXYQ240T RXYQ264T RXYQ288T RXYQ312T RXYQ336T	RXYQ360T RXYQ384T RXYQ408T
Distributed piping	Refnet header	KHRP26M22H (max. 4 branch) KHRP26M33H (max. 8 branch)	KHRP26M22H (max. 4 branch) KHRP26M33H (max. 8 branch) KHRP26M72H (max. 8 branch)	KHRP26M22H (max. 4 branch) KHRP26M33H (max. 8 branch) KHRP26M72H (max. 8 branch) KHRP26M73H (max. 8 branch)	
	Refnet joint	KHRP26A22T KHRP26A33T	KHRP26A22T KHRP26A33T KHRP26M72TU	KHRP26A22T KHRP26A33T KHRP26M72TU KHRP26M73TU	
Outdoor unit multi connection piping kit		—		BHFP22P100U	BHFP22P151U

VRV IV Heat Recovery

OPTIONAL ACCESSORIES		REYQ72T REYQ96T	REYQ120T REYQ144T REYQ168T	REYQ192T REYQ216T REYQ240T REYQ264T REYQ288T REYQ312T REYQ336T	REYQ360T REYQ384T REYQ408T REYQ432T REYQ456T
Distributed piping	Refnet header	KHRP26M33H (max. 8 branch)	KHRP26M33H (max. 8 branch) KHRP26M72H (max. 8 branch)	KHRP25M33H9 (max. 8 branch) KHRP25M72H9 (max. 8 branch) KHRP25M73H9 (max. 8 branch)	
	Refnet joint	KHRP25A22T9 KHRP25A33T9	KHRP25A22T9 KHRP25A33T9 KHRP25M72TU9	KHRP25A22T9 KHRP25A33T9 KHRP25M72TU9 KHRP25M73TU9	
Outdoor unit multi connection piping kit		—		BHFP26P100U	BHFP26P151U

VRV III PC Heat Recovery

OPTIONAL ACCESSORIES		REYQ72PC	REYQ96PC REYQ120PC REYQ144PCTJ
Distributed piping	Refnet header	KHRP25M33H9 (max. 8 branch)	KHRP25M33H9 (max. 8 branch) KHRP25M72H9 (max. 8 branch)
	Refnet joint	KHRP25A22T9 KHRP25A33T9	KHRP25A22T9 KHRP25A33T9 KHRP25M72TU9

OUTDOOR UNITS

REFNET pipe joints & Hail Guard Kit for VRV IV

VRV IV W-Series Heat Pump / Heat Recovery and VRV-III-S

UNIT MODEL NUMBER	VRV IV W-SERIES			VRV-III-S
	RWEYQ72P RWEYQ84P	RWEYQ144P RWEYQ168P	RWEYQ168P RWEYQ252P	RXYMQ36P RXYMQ48P
REFNET Header	KHRP25M33H9 (max. 8 branch) KHRP26M22H9 (max. 4 branch) KHRP26M33H9 (max. 8 branch)	KHRP25M33H9 (max. 8 branch) KHRP25M72H9 (max. 8 branch) KHRP26M22H9 (max. 4 branch) KHRP26M33H9 (max. 8 branch) KHRP26M72H9 (max. 8 branch)	KHRP25M33H9 (max. 8 branch) KHRP25M72H9 (max. 8 branch) KHRP25M73HU9 (max. 8 branch) KHRP26M22H9 (max. 4 branch) KHRP26M33H9 (max. 8 branch) KHRP26M72H9 (max. 8 branch) KHRP26M73HU9 (max. 8 branch)	KHRP26M22H9 (max. 4 branches) KHRP26M33H9 (max. 8 branches)
REFNET Joint	KHRP25M22T9 KHRP25M33T9 KHRP26M22T9 KHRP26M33T9	KHRP25M22T9 KHRP25M33T9 KHRP25M72TU9 KHRP26M22T9 KHRP26M33T9 KHRP26M72TU9	KHRP25M22T9 KHRP25M33T9 KHRP25M72TU9 KHRP25M73TU9 KHRP26M22T9 KHRP26M33T9 KHRP26M72TU9 KHRP26M73TU9	KHRP26M22T9
Outdoor Unit Multi Piping Connection Kit (Heat Pump)		BHFP22MA56U	BHFP22MA84U	
Outdoor Unit Multi Piping Connection Kit (Heat Recovery)		BHFP26MA56U	BHFP26MA84U	

NEW Hail Guard Kit for VRV IV

The optional hail guard kit for VRV IV enables optimal airflow for efficient heat transfer while providing condenser coil protection from hail damage in severe climates. Each hail guard kit, that is field installed, consists of 4 panels (Right, Left, Front and Back).

KIT PART NUMBER	QTY OF KITS PER VRV IV OU MODEL					PANEL DIMENSIONS (H X W X D)			
	R_YQ72T	R_YQ96-168T	R_YQ192T	R_YQ216-336T	R_YQ360-408T	Right Panel	Left Panel	Front Panel	Front Panel
VRV4HGS-K1	1	1	1			45.90" x 26.07" x 4.00"	45.90" x 12.88" x 4.00"	45.90" x 13.24" x 4.00"	45.90" x 32.62" x 4.00"
VRV4HGL-K1			1	2	3			45.90" x 24.03" x 4.00"	45.90" x 44.77" x 4.00"

Service space requirements for the front, back and sides of the condensing unit must be at least 4" greater than the service space requirements provided in the condensing unit installation manual and engineering guide.

If the condensing units in multiple unit installations are installed between 0.75" and 3" maximum between units, the side hail guard panels between modules may not be required. For further separation between the modules, full kits for each module may be required.



Daikin VRV IV provides a solution for large commercial applications desiring heating or cooling.

OUTDOOR UNITS





Ventilation

Air Treatment Systems





Daikin's air treatment systems — creating a better air quality environment.

VENTILATION

Daikin's Outside Air Processing Unit can be integrated with a VRV system to provide outside air treatment and air conditioning in a single system to meet code requirements. It adjusts the temperature of air from outdoors using a fixed discharge temperature control reducing air conditioning load.

In addition to Outside Air Processing Units, we also offer Energy Heat Recovery units. The Energy Heat Recovery VAM-GVJU series units combines compactness, energy conservation, and extensive operation range of outdoor temperatures. This series provides higher enthalpy efficiency, due to the greatly enhanced performance of the thin heat exchanging element. Furthermore, improved external static pressure offers more flexibility for installation.



		OUTSIDE AIR PROCESSING UNIT, FXMQ-MFVJU	ENERGY RECOVERY VENTILATOR, VAM-GVJU
			
VRV Refrigerant Piping		Connectable	Not connectable
VRV Control Wiring		Connectable	
High Efficiency Filter (MERV 8 and MERV 13)		Option	Not available
Ventilation System		Air supply	Air supply and Air exhaust
Power Supply	V/ph/Hz	208-230/1/60	
Airflow Rate	CFM	635 988 1236	300/300/170 470/470/390 600/600/500 1200/1200/930

100% Outside Air Processing Unit



Outside Air Integration Possible

Filter Included

Concealed, Powerful, Compact, Quiet, Fresh Air Quality

This unit provides a zoned, decentralized approach to conditioning outside air. This helps to reduce ductwork and installation time while increasing efficiency and flexibility. Both outside air treatment and space conditioning can be provided from one compact, flexible and efficient VRV system. VRV indoor units and outdoor air processing unit can be connected to the same refrigerant line, enabling enhanced design flexibility.

Features and Benefits

- Available in three capacities, nominal 48, 72 and 96 MBH
- The nominal airflow rates are 635, 988, and 1,236 CFM respectively
- External static pressure capabilities of up to 1.03" W.G. allows for flexibility with duct work and filtration choices
- The indoor unit is controlled to a set cooling and heating discharge air temperature allowing the flexibility to integrate with a standard Daikin indoor unit or duct directly to the space
- A low profile design of only 18.5" high reduces the required installation space and can eliminate mechanical rooms or additional structural supports associated with traditional OA systems
- Indoor Air Quality options include MERV 8 and 13 filters and filter boxes
- Can be connected to all North American Daikin VRV systems
- Connects directly and seamlessly into the Daikin local and centralized controllers

Operational Characteristics

When the suction air temperature is between 66°F and 109°F, the Outside Air Processing Unit operates in cooling, and when between 23°F and 59°F, it operates in heating. The OA processing unit will work in energy saving fan only between 59°F and 66°F.



Layout example

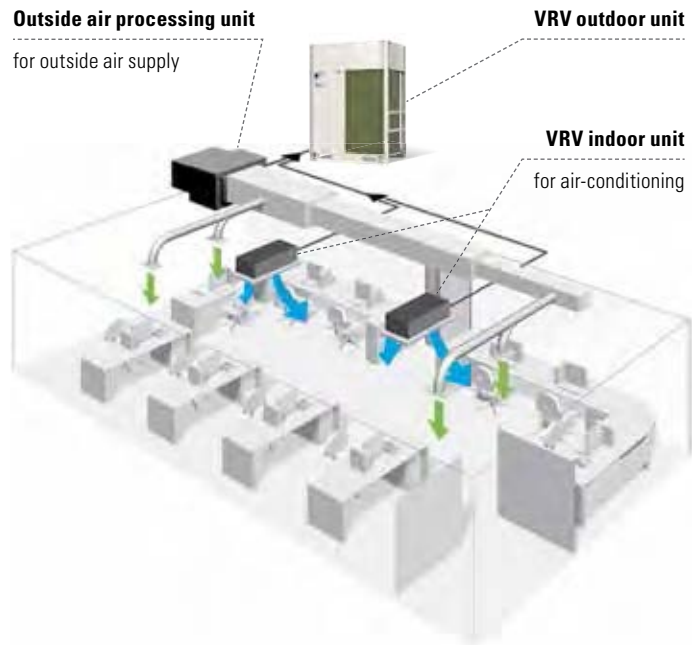

Applications

- Hotel/ conference centers
- Schools
- Retail shopping centers
- Large open-plan offices
- Churches

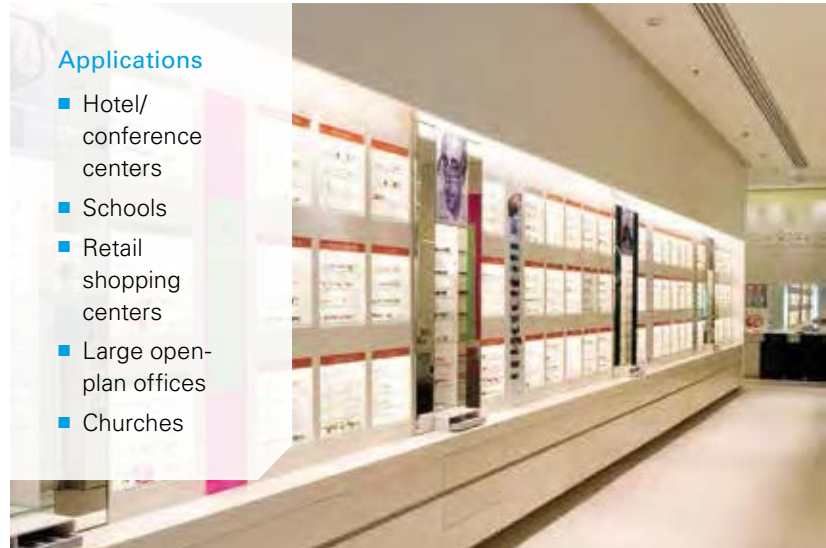

VENTILATION

FXMQ-MFVJU SPECIFICATIONS		4 TON	6 TON	8 TON
Model Name		FXMQ48MFVJU	FXMQ72MFVJU	FXMQ96MFVJU
Power Supply	V/ph/Hz	208-230/1/60		
Rated Cooling Capacity	BTU/h	48,000	72,000	96,000
Rated Heating Capacity	BTU/h	30,000	47,000	59,000
Airflow Rate	CFM	635	988	1,236
Weight	lbs	190	271	
Height	in.	18-1/2		
Width	in.	29-1/4	54-3/8	
Depth	in.	43-5/16		
Sound Pressure	dB(A)	42	47	
External Static Pressure	in. W.G.	0.88	0.96	1.03
Pipe Connections	Gas	in.	5/8	3/4
	Liquid	in.	3/8	
Protection Devices		Fuse Fan Motor Thermal Protector		
External Finish		Galvanized Steel Plate		
Operating Range - Cooling	°F	66 DB/59 WB - 109 DB/90 WB		
Operating Range - Heating	°F	23 DB to 59 DB		
Discharge Air Temp. - Cooling	°F	55-77		
Discharge Air Temp. - Heating	°F	64-86		

Nominal Conditions:

Cooling Mode

Discharge Set Temperature: 64 °F DB
 Outdoor: 91 °F DB, 82 °F WB (68% RH)
 Pipe Length: 25 ft.
 Level Difference: 0 ft.

Heating Mode

Discharge Set Temperature: 77 °F DB
 Outdoor: 32 °F DB, 27 °F WB (50% RH)
 Pipe Length: 25 ft.
 Level Difference: 0 ft.

Note: Specifications are subject to change without notice.

FXMQ-MFVJU ACCESSORIES			
Model Name	FXMQ48MFVJU	FXMQ72MFVJU	FXMQ96MFVJU
Navigation Remote Controller		BRC1E73	
Wireless Remote Controller		BRC4C82	
Remote Sensor Kit		KRCS01-1B	
Wiring Adapter PCB (interface with aux/primary heater, humidifier, OA damper/fan)		KRP1C74	
Group Control Adapter PCB (connects to external BMS)		KRP4A71	
High Efficiency Filter Kit (MERV 13)	DACA-MQ48F131K		DACA-MQ96F131K
High Efficiency Filter Kit (MERV 8)	DACA-MQ48F-8-1K		DACA-MQ96F-8-1K

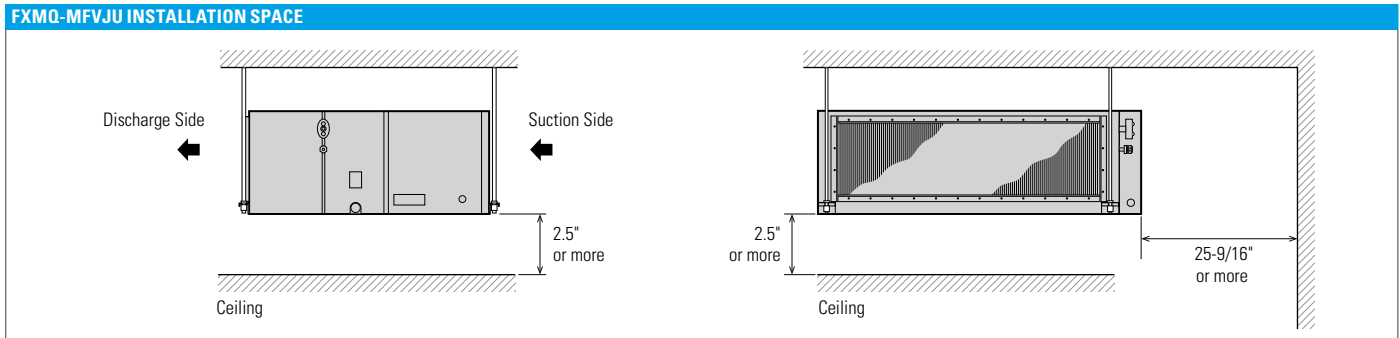

VENTILATION

Energy Recovery Ventilator



Outside Air
Integration Possible

Energy Efficient, Logical, Compact

This Energy Recovery Ventilator is designed to maintain good indoor air quality by providing sufficient levels of outside air and recover waste heat from exhaust air leaving the conditioned zone. It is also fully compatible with Daikin's DIII-NET communications.

Features and Benefits

- Provides energy saving heat recovery ventilation via a heat exchanger with temperature and enthalpy recovery efficiency
- 0-4% return cross leakage rating
- Superior performance with a high efficiency fan and the capability for use in a wide range of climates
- (5 to 122°FDB and 80% RH or less)
- Unique functions such as independent operation, third party equipment interlocking and automatic night purge to reduce cooling loads and increase energy savings
- Interlocked simultaneous operation with VRV indoor units
- Pre-cooling/heating control function to delay the start of ventilation during air conditioner start-up for higher energy savings
- Supply and exhaust fresh-up operation modes to help control pressure within a space
- Filter sign and display reset notifies when filter changes are required
- Temperature recovery efficiency up to 74%
- Enthalpy recovery efficiency up to 65%
- ESP as high as 0.76" W.G.
- Sound levels as low as 25.5 dB(A) for sound sensitive installation locations



Layout example

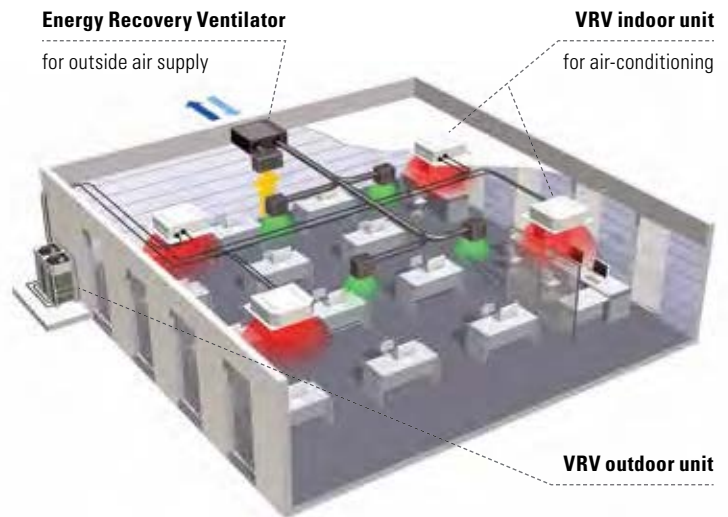

Applications

- Hotel/ conference centers
- Schools
- Retail shopping centers
- Large open-plan offices
- Churches



Heat exchanger with high temperature and enthalpy efficiency



VAM SPECIFICATIONS

Model Name		Airflow		VAM300GVJU	VAM470GVJU	VAM600GVJU	VAM1200GVJU
Temperature Recovery Efficiency Percentage	Cooling	100	%	65	68		72
		75	%	70	72		74
	Heating	100	%	65	66		70
		75	%		69		73
Enthalpy Recovery Efficiency Percentage	Cooling	100	%	40	45		49
		75	%	48	50		52
	Heating	100	%	57	59		60
		75	%	63	65		63
Power Supply		V/ph/Hz		208-230/1/60			
Airflow Rate (H/M/L)	Heat Exchange Mode	CFM		300/300/170	470/470/390	600/600/500	1,200/1,200/930
	Bypass Mode	CFM		300/300/170	470/470/390	600/600/500	1,200/1,200/930
Weight		lbs		71	121	148	346
Height		in.		12-1/16	15-1/4	15-1/4	30-7/8
Width		in.		34-5/8	43-11/16		63-3/4
Depth		in.		31-1/2	32-3/4	47-13/16	
Sound Pressure (H/M/L)		dB(A)		37/33.5/25.5	42/38.5/35	42.5/39/36	44.5/41.5/38.5
External Static Pressure (H/M/L)		in. W.G.		0.64/0.26/0.16	0.73/0.39/0.33	0.76/0.34/0.32	0.56/0.24/0.16
External Finish	Galvanized Steel Plate						
Insulation Material	Self-Extinguishing Urethane Foam						
Connection Duct Diameter		in.		8	10		14
Ambient Conditions		A		5°F ~ 122°F DB 80% RH or less			

VAM-GVJU INSTALLATION EXAMPLE

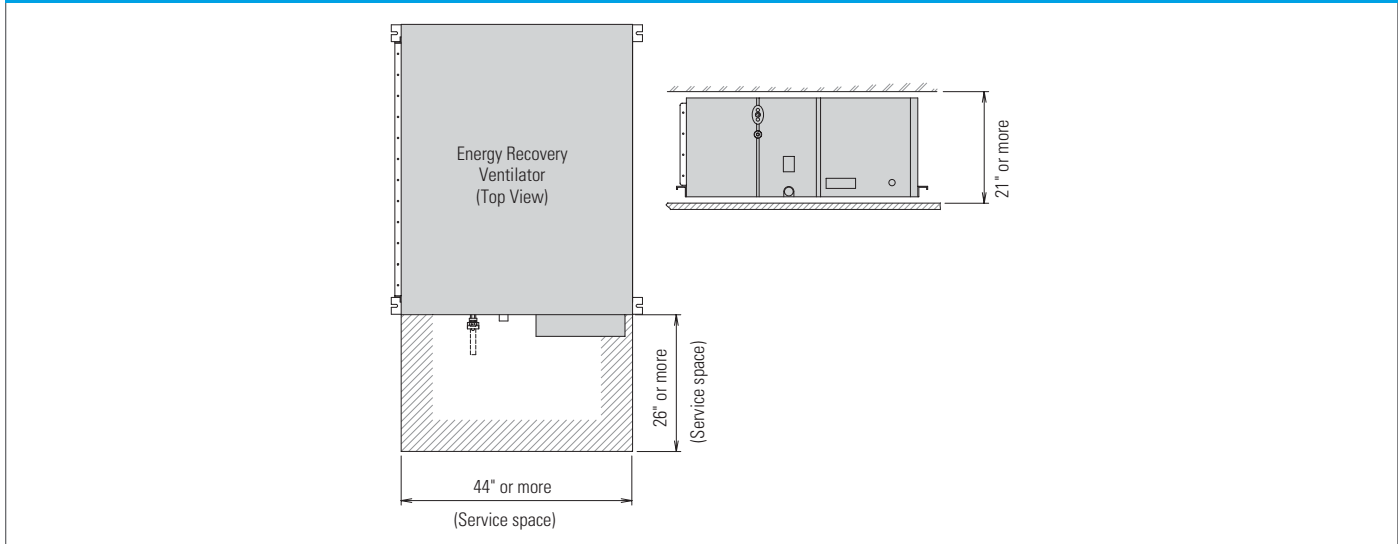

VENTILATION



A man in a grey suit and light blue shirt is sitting at a desk in a modern office. He is looking thoughtfully to the right, with his hand resting on his chin. A silver laptop is open in front of him. The office has large windows in the background and a dark grey wall with a white control panel on the left. A green banner is overlaid on the right side of the image.

Controls

VRV controls matrix

What are your choices?

Individual zone controllers



Multi-zone controllers



Open protocol interfaces



Adapter PCB's

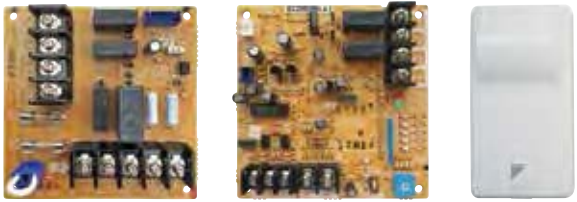



Daikin controls offer comfort control in an easily managed and operated system.

VRV control systems

The VRV controls system provides an advanced architecture that ensures optimum comfort and building management.

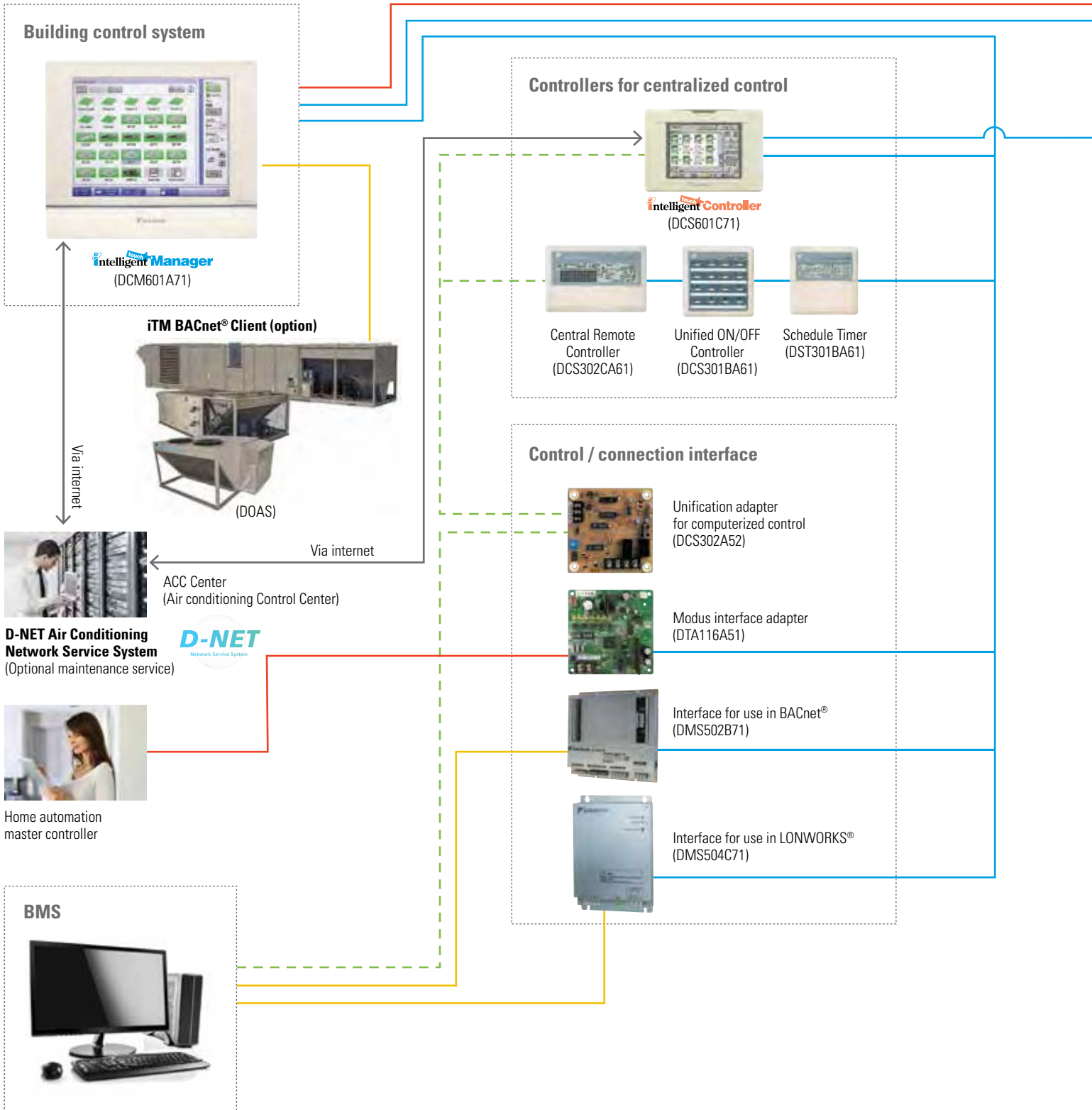

DIII-NET

(Communications Transmission)

DIII-NET, Daikin's unique communication transmission system, links indoor units and various other building equipment—in accordance with applications, scale and conditions—and transmits vast amounts of information between them.

The DIII-NET system provides for:

- Close control and monitoring by integrating a wide variety of indoor units throughout the entire building.
- Saves on in-building wiring cost by using two-conductor non-polar wiring. Simple wiring helps to reduce wiring errors.
- Modular build-up of the VRV system with a total wiring length of up to 6560 ft.
- Multiple equipment control options that can seamlessly control equipment.

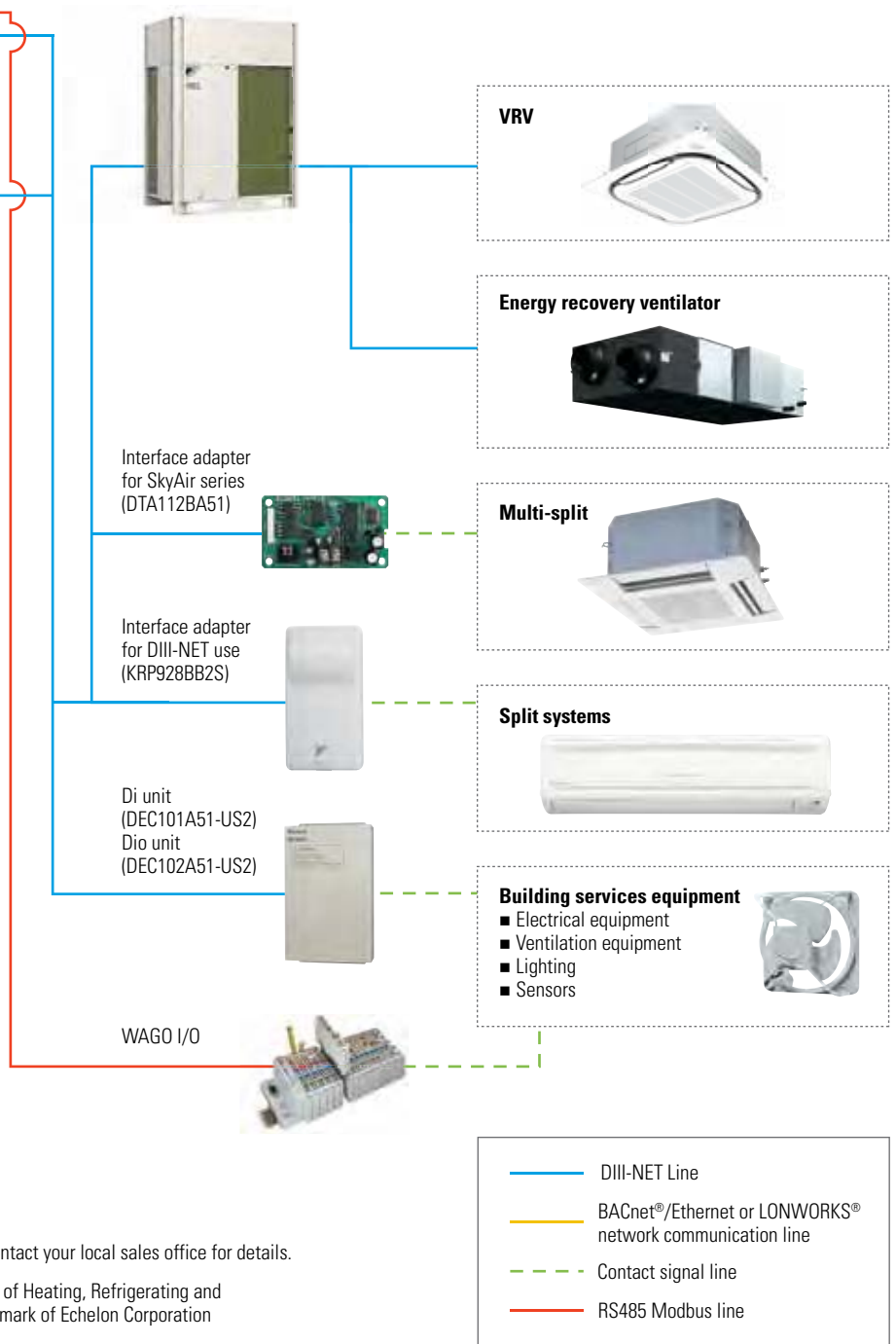

Limitation may apply to some models and functions. Please contact your local sales office for details.

Note: BACnet® is a registered trademark of American Society of Heating, Refrigerating and Air-Conditioning Engineers (ASHRAE). LONWORKS® is a trademark of Echelon Corporation registered in the United States and other countries.

Individual controllers

REMOTE CONTROLLER COMPATIBILITY WITH VRV INDOOR UNITS

	FXFQ-TV	FXZQ	FXUQ	FXDQ	FXMQ	FXHQ	FXAQ	FXL(N)Q	FXTQ
Navigation remote controller (Wired remote controller)	●	●	●	●	●	●	●	●	●
Wireless remote controller (Installed type signal receiver unit)		●				●	●		
Wireless remote controller (Separate type signal receiver unit)				●	●			●	●
Simplified remote controller	●	●	●	●	●	●	●	●	●

● No louver control function

BRC1E73 - Navigation Remote Controller

New and Improved

The Navigation Remote Controller has been enhanced to meet the configuration requirements of Daikin's new VRV indoor units (FXFQ-TVJU and FXUQ-PVJU). The BRC1E73 will provide all the great features and options the market requires. The configurable display and operation buttons will provide as much or as little control as the project requires.



Features and Benefits

Basic Operation

- On/Off, operation mode, setpoint
- **NEW** Up to 5 fan speeds selectable
- Fan speed (enhanced)
- Airflow direction (enhanced)
- **NEW** Individual louver airflow direction
- **NEW** Dual airflow
- **NEW** Auto-draft prevention (prevents air blowing directly on occupants)



Function

- Configurable display — Detailed, Standard, and Simple
- Dual or single cool and heat setpoints for occupied periods
- Independent setback setpoints for unoccupied periods
- **NEW** Automatic Setback by occupancy sensor
- **NEW** Automatic Off by occupancy sensor
- Unwanted buttons/operation modes can be disabled

- Setpoint range limitation
- Individual button prohibits/lockout
- Auto-changeover for Heat Recovery and Heat Pump systems with dual or single setpoints
- **NEW** Self-cleaning filter panel
- Automatic adjustment for Daylight Savings Time (DST) (enhanced)
- Built in 7, 5+2, 5+1+1, and 1 (everyday) schedule with up to 5 actions per day with independent cooling, heating and setback setpoints

More Features

- Backlit display
- Room temperature sensor
- 12/24 hour clock
- Fahrenheit/celsius selectable
- English/French/Spanish languages selectable
- Remote control group - up to 16 indoor units

INDIVIDUAL CONTROL CAPABILITIES			
System Capabilities	Daikin Controls Options		
	 BRC1E73 Navigation Remote Controller	 BRC2A71 Simplified Wired Remote Controller	 Wireless Remote Controller (model depends on unit)
Communications	2 Wire / DIII Net	2 Wire / DIII Net	Infrared
°F/°C Selector	●	°F only	°F only
Backlit LCD display	●		
Room temperature display	●		
Schedule and setback capabilities (with Time and Date display)	●		
User restriction options	●		
On/Off, Operation mode, Setpoint, Fan speed	●	●	●
Louver position adjustment	●		●
Reports system malfunctions	●	●	●
Space temperature sensor	●		
Simultaneous operation with Daikin multi-zone controllers	●	●	●
Simultaneous operation with BACnet® and LonWorks®	●	●	●
Group control capacity	Up to 16 indoor units	Up to 16 indoor units	Up to 16 indoor units

Auto-changeover

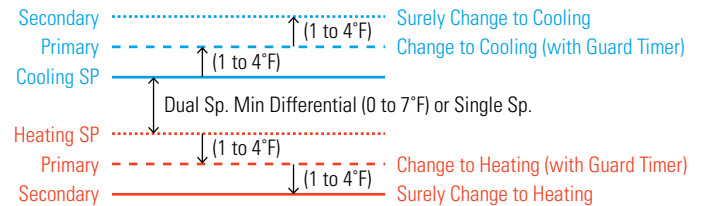

Automatic changeover is available for Heat Pump system and Heat Recovery systems. The setpoint for cooling and heating are configurable with a minimum differential of 0 to 7°F or single setpoint. The changeover is automatically controlled to happen in either of the following two cases:

- Case 1:** Changeover at the primary changeover temperature after the guard timer expires.
 - In default, the primary changeover setpoint is 1°F above cooling setpoint or 1°F below heating setpoint, which is configurable between 1°F – 4°F.
 - In default, the guard timer is 60 minutes, which is selectable among 15, 30, 60 (default) or 90 minutes.
 - The initiation of guard timer is built in to help prevent frequent changeover which may cause energy loss.
- Case 2:** Changeover at the secondary changeover temperature.
 - In default, the secondary changeover temperature is 1°F above the primary changeover temperature for cooling or 1°F below the primary changeover temperature for heating, which is configurable between 1°F – 4°F.
 - Case 2 will happen while the guard time is active in case 1.



Individual controllers (continued)

BRC1E73 - Navigation Remote Controller (continued)

Configurable Display Mode – Detailed, Standard, Simple

DISPLAY MODE	DETAILED	STANDARD	SIMPLE NEW
Display Image			
On/Off status on LED (LED blinks when an error occurs)	●	●	●
Mode	● ¹	● ¹	● ¹
Setpoint (Dual/Single)	● ²	● ²	● ²
Room temperature	●	●	●
Fan speed	● ³	● ³	● ³
Airflow direction (when a louver is available)	●		
Day and Time	● ³		
Status icon	● ³	● ³	
Key lock icon	●	●	
Error message	●	●	

¹ OFF can be displayed instead of the operation mode while the unit is turned off with the field setting

² Can be removed from the display while the unit is turned off with a field setting

³ Can be removed from the display with a field setting

On/Off Display Option



Clear display

- Backlit display
 - Backlight helps operating in dark rooms.
- Dot matrix display
 - A combination of fine dots enables various icons.
 - Large text display is easy to see.

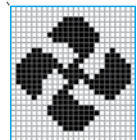

Simple operation

- Large buttons and arrow keys
 - Large buttons and arrow keys enable easy operation. Basic setting such as fan speed and temperature can be intuitively operated. For other settings just select the function from the menu list.

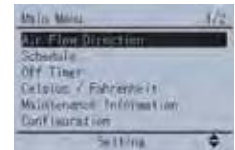

Optional Face Decals –

Hides unnecessary (locked/prohibited) buttons

USED WITH	SINGLE SETPOINT MODE			DUAL SETPOINT MODE		
Model	 BRC1E73RM	 BRC1E73RF	 BRC1E73RMF	 BRC1E73RM2	 BRC1E73RF2	 BRC1E73RMF2
On/Off	●	●	●	●	●	●
Mode	●	●	●	●	●	●
Fan		●	●		●	●
Up, Down	●	●	●	●	●	●
Left, Right				●	●	●
Menu/Ok						
Cancel						

A man in a red sweater is sitting at a desk in a modern office, working on a laptop. The desk is cluttered with papers and a printer. In the background, there is a window with a view of a building and a modern office interior with a staircase.

Daikin controls has advanced sensing functions so the operation can be optimized for both occupied and unoccupied conditions.

Individual controllers (continued)

BRC1E73 - Navigation Remote Controller (continued)

Energy saving

■ Automatic Off by occupancy sensor

- The indoor unit will turn off when it is determined that the room is unoccupied after a specified time has elapsed.
- Can be used in conjunction with the Auto Setback by sensor function

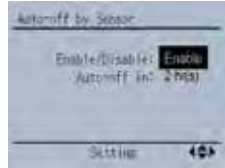

■ Auto-setback by sensor

- The cooling and heating setpoints will gradually relax (configurable) internally when the room is determined to be unoccupied.
- The internal setpoint will return to the original setpoint when room occupancy is detected.



Automatic Off energy savings

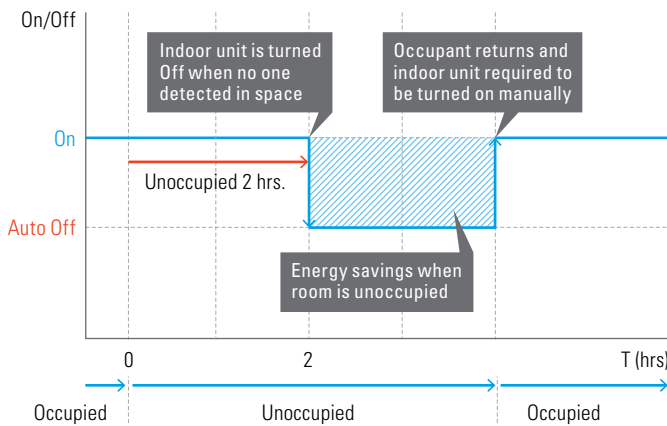

Automatic setback energy savings

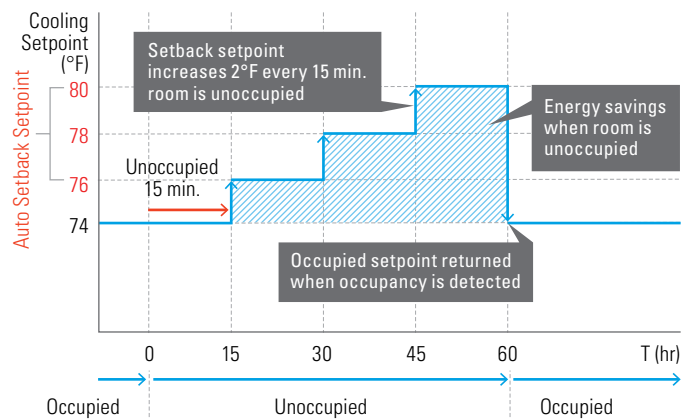

College classroom sample (a summer Monday case)

1) 8:30 **ON**

The first period starts and the air conditioner starts the cooling operation.

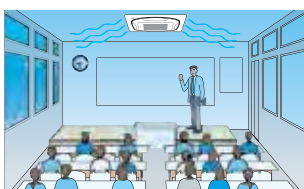

2) 10:00 **OFF**

In the second period, the classroom is unoccupied and the air conditioner stops.

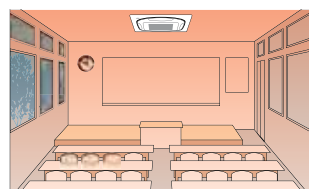

3) 13:00 **ON**

When the third period starts, operation starts again.

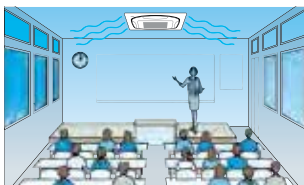

4) 15:00 **OFF**

After the third period, the classroom becomes vacant again and the air conditioner stops.

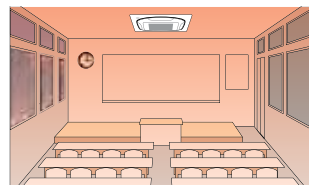

Comfort

- Individual airflow direction[†]
 - Airflow direction of each of the four air outlets can be controlled individually.
 - (Positions 0 to 4, Swing, and No individual setting are selectable.)
- Auto airflow rate[†]
 - Airflow rate is automatically controlled in accordance with the difference between room temperature and set temperature.

[†] Only available for VRV 4-Way Flow Ceiling Suspended type FXUQ-P series and Ceiling Mounted Cassette (Round Flow with Sensing) type FXFQ-T series.

Individual airflow direction

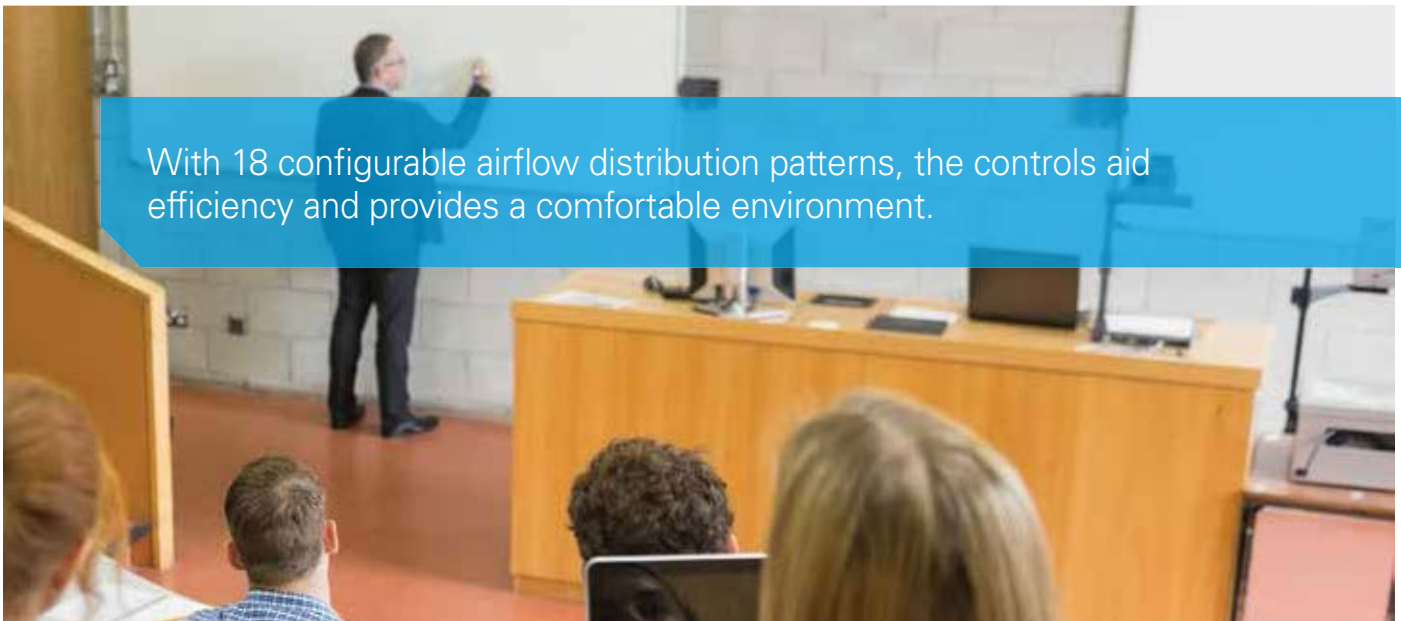
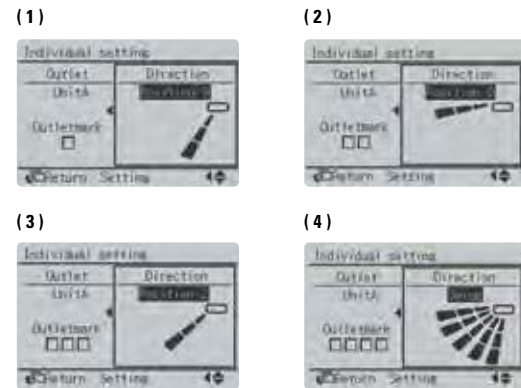
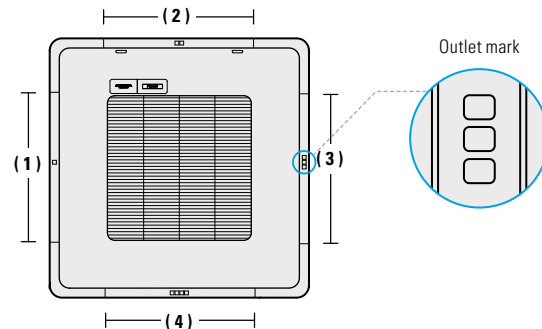

With 18 configurable airflow distribution patterns, the controls aid efficiency and provides a comfortable environment.

Individual controllers (continued)

BRC4C82/BRC7E818/BRC7E83/BRC7E830 - Wireless Remote Controller

- The same operation modes and settings as with wired remote controllers are possible.
 - Individual airflow direction, auto airflow rate and sensing sensor control can be set only via wired remote controller BRC1E73. Cannot be set via other remote controllers.
- A compact signal receiver unit (separate type) to be mounted into a wall or ceiling is included.
 - The Ceiling Suspended and Wall Mount indoor units use signal receivers that are mounted in the indoor unit.



Wireless remote controller



Signal receiver unit (separate type)

Wireless remote controller and signal receiver unit are sold as a set.

BRC2A71 - Simplified Remote Controller

- Economical controls solution
- Suitable for use in hotels rooms, hallways, reception areas and conference rooms
- Features
 - On/Off
 - Operation mode
 - Single setpoint
 - Fan speed adjustment
 - Can be used with the optional remote temperature sensor for sensing room temperature



Simplified remote controller

USED WITH	FACE PLATE OPTIONS		
	BRC2A71RS	BRC2A71R	BRC2A71RU
Model			
On/Off	●	●	●
Mode	●	●	
Fan	●		●
Up, Down	●	●	●

By providing individual zone control, the occupant of each space has the ability to set the room temperature where they feel most comfortable.



Centralized controllers

DCS302C71 - Central Remote Controller

Maximum 64 groups (zones) of indoor units can be controlled individually.



- Maximum 64 groups (128 indoor units) controllable
- Maximum 128 groups (128 indoor units) are controllable by using 2 central remote controllers, which can control from 2 different places.
- Zone control
- Malfunction code display
- Maximum wiring length 3280 ft. (Total: 6560 ft.)
- Connectable with Unified ON/OFF controller, schedule timer and BMS system
- Airflow volume and direction can be controlled individually for indoor units in each group operation.
- Ventilation volume and mode can be controlled for Energy Recovery Ventilator.
- Up to 4 ON/OFF pairs can be set per day by connecting a schedule timer.



DCS301C71 - Unified On/Off Controller

Maximum 16 groups of indoor units can be operated simultaneously/individually.

- Maximum 16 groups (128 indoor units) controllable
- Operating status indication (Normal operation, Alarm)
- Centralized control indication
- Maximum wiring length 3280 ft. (total: 6560 ft.)
- Compact size casing (thickness: 0.63in)
- Connectable with Central Remote Controller, Schedule timer and BMS system



DST301BA61 - Schedule Timer

Maximum 128 indoor units can be operated as programmed schedule.

- Maximum 128 indoor units controllable
- When used in combination with a central remote controller, a maximum of 8 weekly schedule patterns can be set, while the central controller can be used to select desired zones. Up to 2 ON/OFF pairs can be set per day.
- Maximum 48 hours back up power supply
- Maximum wiring length 3280 ft. (total: 6560 ft.)
- Compact size casing (thickness: 0.63in)
- Connectable with Central Remote Controller, Unified ON/OFF controller and BMS system



The Central Controllers can monitor and control indoor units by either group or zone. Their easy-to-read liquid crystal displays (LCDs) allow you to orchestrate and monitor temperature, time, and airflow volume, etc. across your entire system at the touch of button.

Advanced multi-zone controllers

DCM601A71 - intelligent Touch Manager (iTM)

One for all

The intelligent Touch Manager (iTM) is an advanced multi-zone controller that provides the most cost-effective way to control and monitor the Daikin VRV system.

Centralized and Advanced VRV Control

Up to 64 Indoor Unit Groups (128 actual Indoor Units) can be monitored and controlled with individual Cool and Heat Setpoints, Setpoint Range Limitation, Setback Setpoints, and Auto changeover to meet your expectations and project requirements. Up to 512 Indoor Unit Groups (1024 actual Indoor Units) can be monitored and controlled with the addition of up to 7 optional iTM Plus Adapters.

Ancillary Equipment Control

Integrates and/or interlocks sensors, switches, dampers, fans, pumps, and lighting with Daikin Indoor Units.

Web Access and Alert E-mail

Allows daily remote monitoring and control with the Web/E-mail function that can be accessed via the facility's Local Area Network or your Internet connection. Sends Error E-mail to mobile devices with the Web/E-mail function.

Tenant Billing

Determines energy consumption of shared condensing units based upon tenant (Indoor Unit) demand with optional PPD Software option (DCM002A71).

Features

- 10.4" LCD touch screen, USB drive
- Advanced, scalable and cost-effective management system
 - Up to 650 points (max 512 indoor unit groups (1024 indoor units))
 - Floor plan layout view



intelligent Manager

Functions

- Dual setpoints or Single setpoint in Occ or Setback in Unocc
- Setpoint Range Limitation
- Scheduling (7 day, Weekday-Weekend, Weekday-Saturday-Sunday, Everyday)
- Optimum Start and Timed Override
- Advanced Auto changeover
 - Applicable to both VRV Heat Pump and Heat Recovery systems
 - Fixed, Individual, Average and Vote methods
- Web Accessibility and Alert Email (standardized)
 - All screen views and configuration menus can be accessed through Web
- WAGO I/O
 - Monitor and control 3rd party equipment with Di, Do and Ai signals
 - Up to 512 management points
 - Interlock function with indoor units and ancillary equipment
- iTM BACnet® Client (option)
 - Enabling the BACnet Client option the iTM uses the BACnet protocol BACnet IP
 - Allows for full monitoring and control of 3rd party BACnet capable equipment
 - Up to 512 BACnet management points

iTM system overview

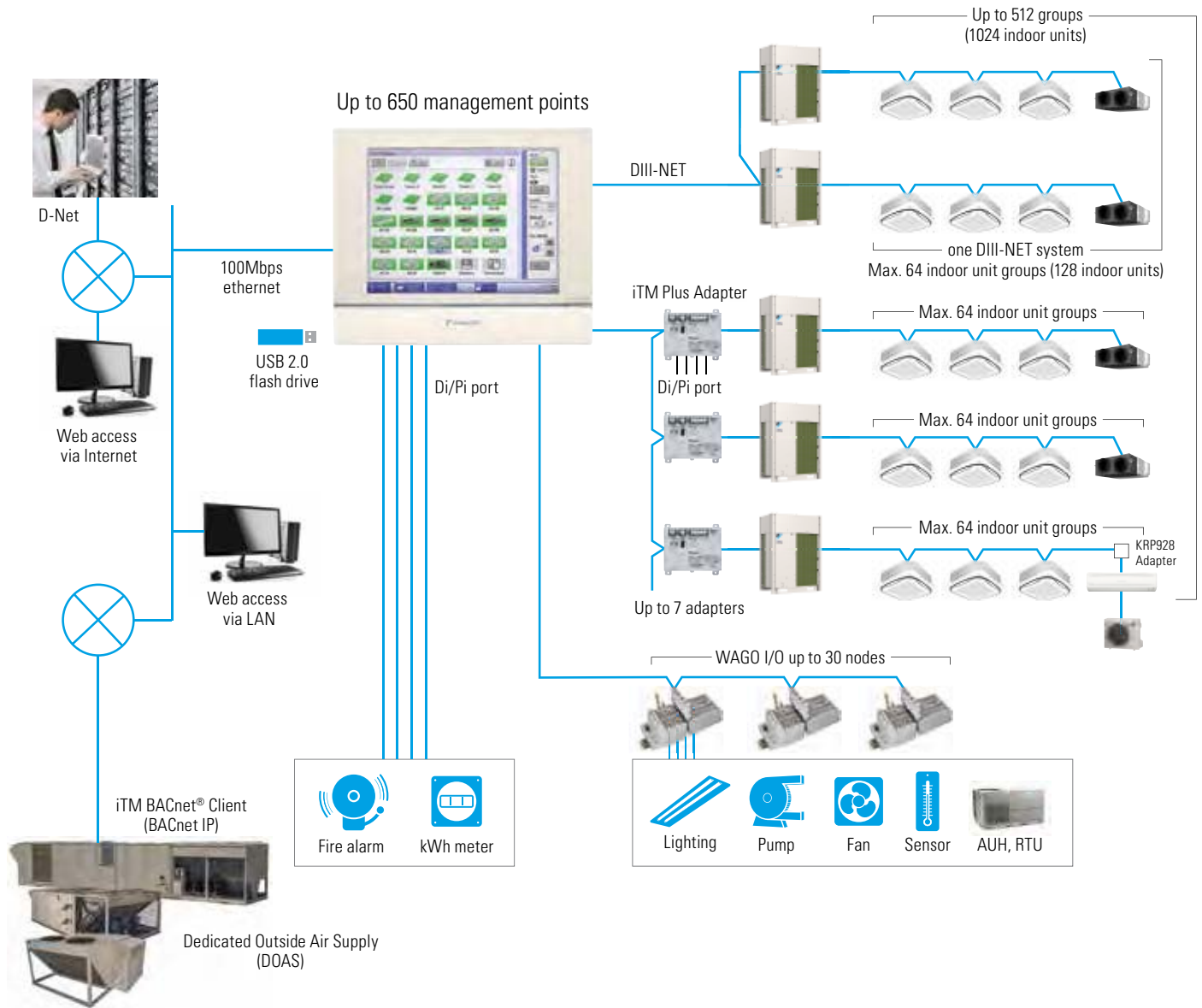

CONTROLS

Advanced multi-zone controllers (continued)

DCS601C71 - intelligent Touch Controller (iTC)

Centralized and Advanced VRV Control

Up to 64 Indoor Unit Groups (128 actual Indoor Units) can be monitored and controlled with individual Cool and Heat Setpoints, Setpoint Range Limitation, Setback Setpoints, and Auto changeover to meet your expectations and project requirements. Up to 128 Indoor Unit Groups (256 actual Indoor Units) can be monitored and controlled with the addition of the Optional DIII-Net Plus Adapter (DCS601A72).

Ancillary Equipment Control

Integrates and/or interlocks sensors, switches, dampers, fans, pumps, and lighting with Daikin Indoor Units.

Web Access and Alert E-mail

Allows daily remote monitoring and control with the Web/E-mail Software option that can be accessed via the facility's Local Area Network or your Internet connection. Sends Error E-mail to mobile devices with the optional Web/E-mail Software option (DCS004A71).

Tenant Billing

Determines energy consumption of shared condensing units based upon tenant (Indoor Unit) demand with optional PPD Software option (DCS002A71).

Features

- Color LCD touch panel icon display
- Simplified engineering
- Multi language (English, French, Italian, German, Spanish)
- Yearly schedule
- Independent dual or single setpoints for occupied and setback operation
- Auto heat/cool change-over
- Enhanced history function
- Simple Interlock Function
- Doubling of number of connectable indoor units by adding a DIII-NET Plus Adapter (option)



intelligent touch Controller

Functions

- Advanced Zone Level Control
 - Add advanced temperature control functions from a single multi-zone controller
- Independent Cool, Heat, and Setback Setpoints
- Advanced Auto changeover
 - Applicable to both VRV Heat Pump and Heat Recovery systems
 - Fixed, Individual, and Average methods
- Scheduling (7 day, Weekday-Weekend, Weekday-Saturday-Sunday)
- Centralized Control with three different view styles
- Setpoint Range Limit
- Simple interlock
- Web server (option)
- Alarm E-mail (option)
- PPD (tenant billing option)
- HTTP interface (option)



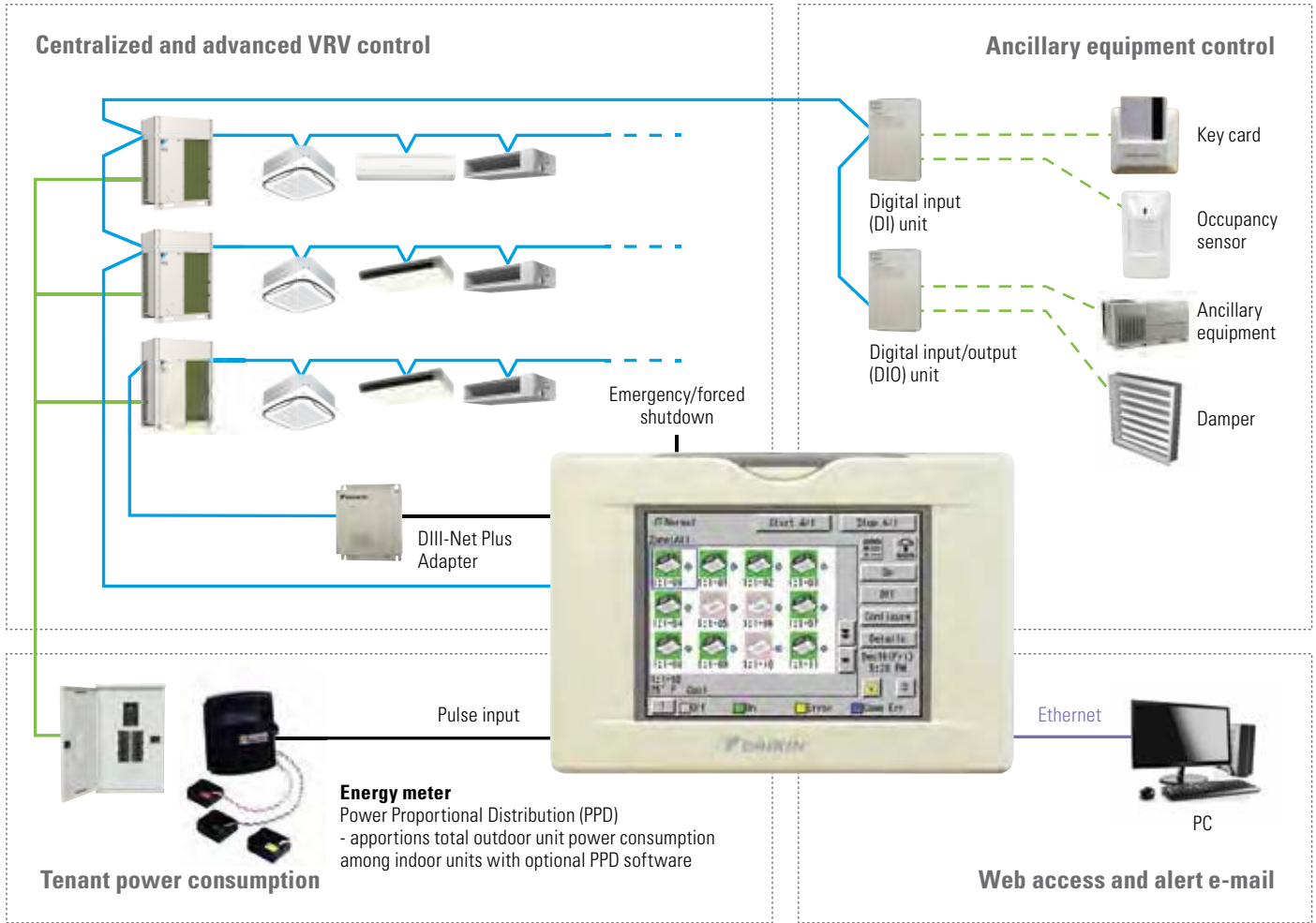

CONTROLS

Open protocol interfaces

Interface for BACnet®, LonWorks® and Modbus

BACnet® features

- BACnet®: Building Automation and Control Networks
 - Standard open protocol based on ANSI/ASHREA Standard 135
- Monitor/Control indoor unit's points
- Monitor/Control up to 256 indoor units groups (512 indoor units)
- Certified by BACnet Testing Laboratories (BTL) 
- Manage up to 4 DIII-Net systems
 - Option Board (DAM411B51) required

LonWorks® features

- BMS interface based on LonTalk®
- Gateway between Daikin DIII-Net and BMS LonTalk® work station
 - Manages up to 64 indoor unit groups (128 indoor units) with network variables for each group
 - Manages 1 DIII-Net system
- Lon Interface communicates over twisted pair wire
- External Interface File (XIF) documents device information available at www.daikinac.com

BACnet/LonWorks system overview

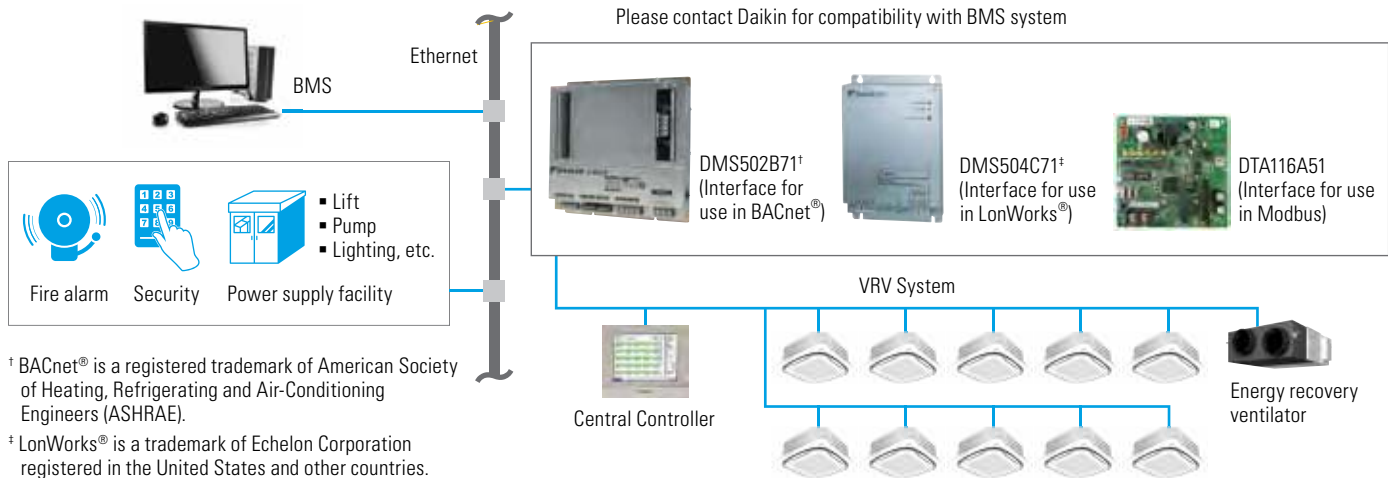

Modbus features

- BMS interface based on Modbus (RS485)
- Gateway between Daikin DIII-Net and BMS Modbus workstation
 - Manages up to 16 VRV indoor units connected to up to 2 outdoor units
- Modbus interface communicates via Modbus RTU

Daikin's BACnet, Lonworks and Modbus interface units provides control for all VRV systems.

D-NET Air Conditioning Network Service System

Save energy. Protect your equipment investment. Maintain comfort levels.



D-NET connects your equipment to our monitoring center over the web. We continually monitor more than 80 data points in your equipment*, so we know exactly how your systems are performing. We also monitor outside conditions from

more than 400 locations across the United States and Canada, so we know what kind of weather you're up against. Putting this information together, we know if your systems can be optimized remotely to reduce your energy consumption.

D-NET Air Conditioning Network Service System overview

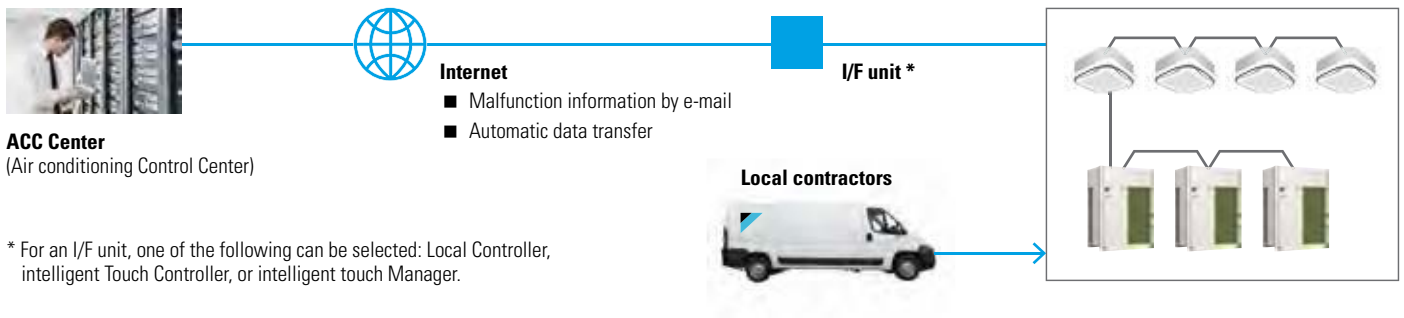

Option list

Individual zone controllers

ITEM	MODEL NO.	FUNCTION
Navigation Remote Controller	BRC1E73	Programmable zone controller
Wireless Remote Controller	BRC4C82 BRC7C812 BRC7E818 BRC7E83 BRC7E830	Hand-held zone controller with infrared receiver kit
Simplified Remote Controller	BRC2A71	Non-programmable zone controller

Centralized controllers

ITEM	MODEL NO.	FUNCTION
Central remote controller	DCS302C71	Up to 64 groups of indoor units (128 units) can be connected, and ON/OFF, temperature setting and monitoring can be accomplished individually or simultaneously. Connect up to 2 controller in one system.
Unified ON/OFF controller	DCS301C71	Up to 16 groups of indoor units (128 units) can be turned, ON/OFF individually or simultaneously, and operation and malfunction status can be displayed. Can be used in combination with up to 8 controllers.
Schedule Timer	DST301BA61	Weekly schedule can be programmed by the controller for up to 64 groups of indoor units (128 units). Can turn units ON/OFF twice per day.

Advanced multi-zone controllers

ITEM		MODEL NO.	FUNCTION	
intelligent Touch Controller	Basic	Hardware	intelligent Touch Controller DCS601C71	Air-Conditioning management system that can control up to 64 groups (10 outdoor units).
	Optional	Hardware	DIII-Net plus Adapter DCS601C72	Additional 64 groups (10 outdoor units) are possible.
		Software	iTC PPD Option DCS002A71	Power consumption of indoor units are calculated based on operation status of the indoor unit and outdoor unit power consumption measured by kWh meter.
			iTC Web Option DCS004A71	Provides access to ITC via web browser with PC. Error Email sent when errors occur.
		iTC HTTP Interface Option DCS007A51	Interface to home automation system certified with Crestron home automation	
intelligent Touch Manager	Basic	Hardware	intelligent Touch Manager DCM601A71	Air-conditioning management system that can be controlled by touch screen or web browser to monitor and control up to 64 groups (10 outdoor units).
	Optional	Hardware	iTM Plus Adapter DCM601A72	Maximum 7 iTM Plus Adapters can be connected to intelligent Touch Manager. Each iTM Plus Adapter can add and additional 64 groups (10 outdoor units)
		Software	iTM PPD Option DCM002A71	Power consumption of indoor units are calculated based on operation status of the indoor unit and outdoor unit power consumption measured by kWh meter.

Open protocol interface

ITEM	MODEL NO.	FUNCTION
Interface for use in BACnet®	DMS502B71	Interface unit to allow communications between VRV and BMS. Operation and monitoring of air-conditioning systems through BACnet® communication.
Optional DIII board	DAM411B51	Expansion kit, installed on DMS502B71, to provide 2 more DIII-NET communication ports. Not usable independently.
Interface for use in LONWORKS®	DMS504C71	Interface unit to allow communications between VRV and BMS. Operation and monitoring of air-conditioning systems through LonWorks® communication
Interface for use in Modbus	DTA116A51	Use of the Modbus protocol enables the connection of the VRV system with a variety of home automation and BMS systems from other manufacturers.

Adapters

ITEM	MODEL NO.	FUNCTION
Digital Input (Di) Unit	DEC101A51-US2	Monitor On/Off and Error status of ancillary equipment
Digital Input/Output (Dio) Unit	DEC102A51-US2	Monitor and control of ancillary equipment
DIII-Net Expander Adapter	DTA109A51	Apply to increase the number of outdoor units (up to another 10) connected in one DIII-Net system. Apply to overcome communication errors in electrically noisy environments.
Unification Adapter for Computerized Control	DCS302A72	Turn On/Off the system from a central panel through Centralized Controller or iTouch Controller. Monitor On/Off and Error Status.
External control Adapter for Outdoor Unit	DTA104A53/61/62	Unified changeover of Cool/Heat mode. To change the mode of several outdoor units by one remote controller. Demand Control. Low Noise Control: -2 to 3 dB of outdoor unit
Group Control Adapter	KRP4A71/72/73/74	Turn On/Off Remote Control Group. Change setpoint (with resistance interface 0-135 ohm). Monitor On/Off and Error status
ABC Terminal Kit	BRP2A81	Remotely manage the operating mode of the heat pump system. Integration point for ambient thermostats to engage lock-out
Wiring Adapter	KRP1C74/75	Thermo-on status. Fan status. AUX heater output. Humidifier output
RA Interface Adapter for DIII-Net Use	KRP928B2S	Mini-split can be controlled through DIII-NET
RA PCB Adapter for Time Clock	KRP413A1S	Remotely Start / Stop for mini-split indoor units

WAGO

ITEM	MODEL NO.	FUNCTION
Basic Kit (required for each Node)	51291052	Bus Coupler MODBUS (RS485) Communication, 24VDC input
		End Module To loop the internal bus
		Connector D-Sub male connector: 9 pin, 2 horizontal wire entries, one input and one output
		24 VDC Power Supply Input voltage 110 – 240VAC, output voltage 24VDC @ 2.5A
2 Channel Digital Input	750-400	2 Channel, DC 24V, 3.0ms, high-side switching
4 Channel Digital Input	750-432	4 Channel, DC 24V, 3.0ms, low-side switching, w/(+) terminal
2 Channel Digital Output	750-513/000-001	2 Channel, AC 230V, DC 30V, AC/DC 2A, isolated outputs
	750-454	2 Channel, 4 - 20 mA, Differential Inputs
	750-479	2 Channel, DC ± 10 V, Differential measurement input
	750-461/020-000	2 Channel, NTC 20K Ohm Resistance
24 VDC Power Supply (Passive) (required for every 32 contact points used)	750-602	24 VDC Passive
Wiring	Field Supplied	2 conductor 24 – 18 AWG stranded





Support and tools

Support and tools

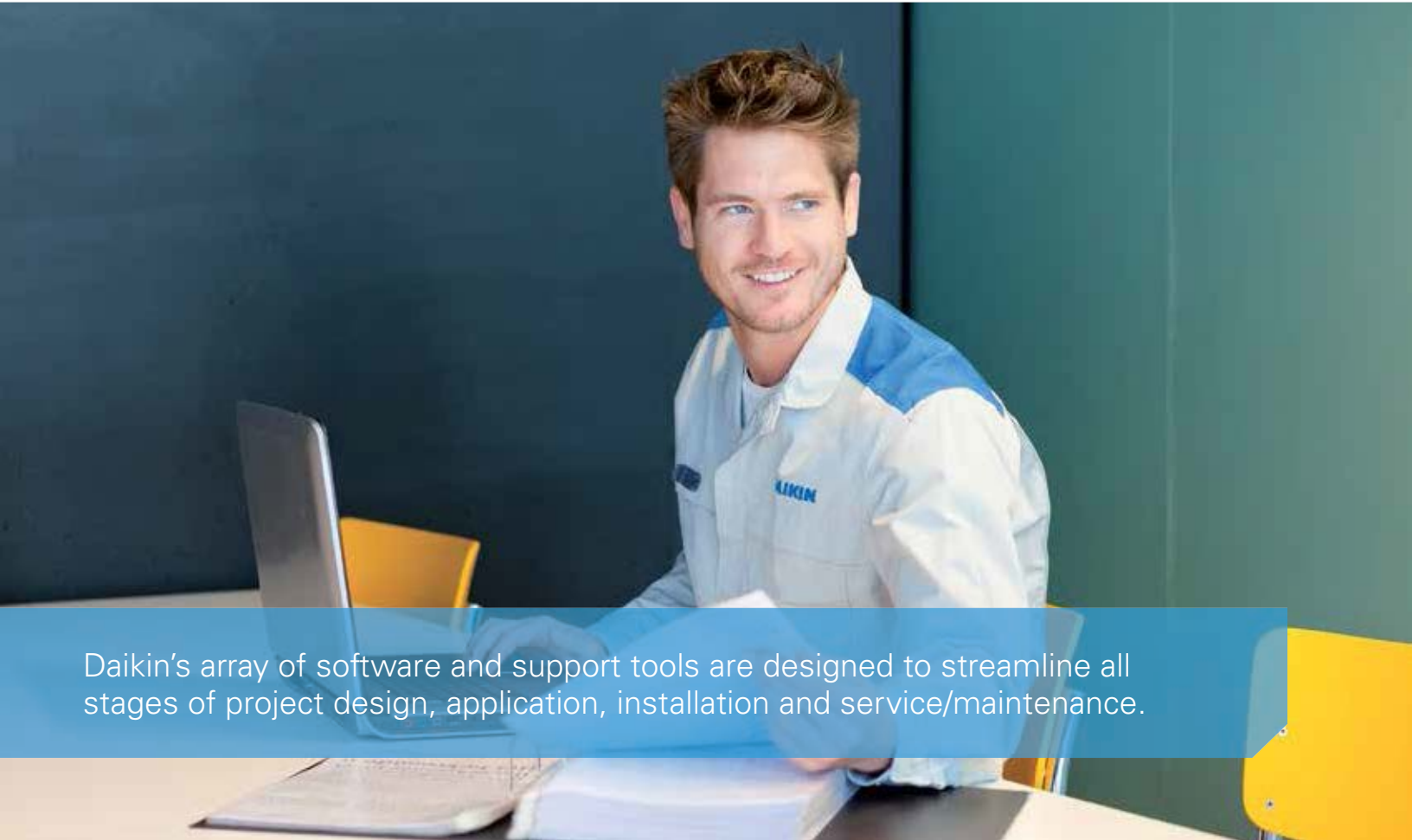











Daikin's array of software and support tools are designed to streamline all stages of project design, application, installation and service/maintenance.

Daikin provides multiple tools to aid the design, selection, analysis, submission, and general support for its line up of ductless, rooftop, light commercial split and specifically for the full line of Daikin VRV systems.

The tools have been designed to be simple to use, easily accessible and to address the various considerations and steps in the evolution of a residential or commercial project, aimed at helping the architect, consulting engineer, contractor, installation technician, and service company to enhance workflows and general project execution.

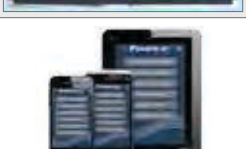
Daikin VRV support and tools overview

CATEGORIES		TOOLS																
		Xpress	W-III Xpress	Ventilation Xpress	Controls Configurator	Online Energy Calculator	IES-VE Daikin VRV plug-in	Performance curves for third-party energy simulation Programs	CAD drawings	Revit models	Reference Charge Calculator	Ventilation Rate Calculator	Daikin City (including Guide Specs, IOMS etc.)	Daikin eQuip application	Dr. Daikin	VRV Configurator	Service Checker	Online Spare Parts Bank
 Selection		●	●	●	●													
 Energy screening and simulation						●	●	●										
 Design and verification									●	●	●	●						
 Online and tablet reference (spec, data, submittal)													●					
 Smartphone and mobile reference														●	●			
 After sales and service																●	●	●

Support and tools



Xpress



Selection software

A key tool for Reps, Consulting Engineers and Contractors to use is the suite of **Xpress** selection software. This tool is a windows based EXE file designed to provide quick, easy and above all accurate selections of VRV systems and ventilation devices. Inputs can be customized to meet a variety of project needs and has the following features and benefits:

- Fully array of software configuration settings
- Select and customize indoor unit types with options/accessories
- Optimize condensing unit selections based on block load characteristics
- Define pipe sizes and lengths and both local and centralized wiring schemes
- Define and generate selection reports in Word (RTF), Excel (CSV), or CAD (DXF) formats

As controls for VRF systems become much more sophisticated at both a zone and building level, ensuring the full array of features are captured, Daikin has developed a simple **controls configurator tool** allowing the consulting engineer or contractor to capture all of the features that are needed to be utilized with the suite of controls products from Daikin so to ensure that the commissioning engineer can then set-up and configure the system appropriately at start up.



IES-VE plug-in for Daikin VRV



Energy screening and simulation tools

With the continued trend in looking at building costs beyond just the 1st cost, accurately screening or simulating the performance of systems in buildings at the conceptual stage is more important than ever. Daikin recognizes this need and has developed a variety of support tools for this purpose.

Online VRV energy calculator

- Easy access and registration via online.
- Free of charge and easy to use.
- Allows for a semi-dynamic energy screening to be completed for VRV only. Provides useful information such as part load curves, estimated annualized operating costs etc.

IES-VE plug-in for Daikin VRV

- One of the leading Energy Simulation programs in Europe is now gaining awareness and a growing user-base in North America.
- With the Daikin VRV plug in for IES-VE you can take advantage of the enhanced energy simulation capabilities with the IES platform and combine in a fully validated modeling methodology for Daikin VRV systems including the innovative and energy saving "VRT" function. The results of the IES-VE simulations can be utilized for LEED, California Title 24 and other regulatory energy simulation requirements.

Performance curve/plugin for 3rd party modeling software

- Daikin have developed curves, instructions and sample building files for a variety of other 3rd party energy simulation software programs such as:
 - eQuest
 - Trace 700
 - HAP
 - Energy Pro
 - Energy Plus (VRV HP only)

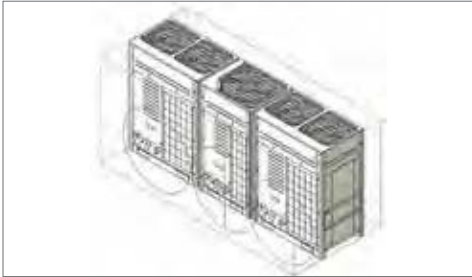

Revit



Design and verification

Equipment Selection and Energy Simulation only reflect the early stages of a project evolution. At Daikin we recognize the importance of additionally providing resources to the Engineer and Architect community as well as contractors as follows:

- **CAD** files for all products in multiple formats (DWG and DXF)
- **Revit** files for BIM architecture for all products
- **Refrigerant Charge Calculator**
 - Quick check of the total refrigerant charge in a VRV System based on applied pipe-lengths and combination ratio's etc
 - Quick check of the minimum room volume (occupied space) that system charge can be utilized in per ASHRAE Standard 15-2010 and ASHRAE Standard 34-2010.
- **Ventilation Rate Calculator**
 - Easy to use calculator to determine ventilation rates required for different room sizes and applications in accordance with ASHRAE Standard 62.1-2013.



www.DaikinCity.com



Online and tablet reference material

Daikin City serves as the multi-functional portal for all disciplines interested in or already using Daikin products and technologies for a project. More than just a typical website, Daikin City provides:

- Energy-saving characteristics of VRV systems in various vertical market buildings
- Product videos and feature summaries via the communications center
- A fully stocked library of information simply arranged for ease of finding any piece of Daikin information you may need such as IOM's, brochures, engineering data, and application guides etc (registration required).
- Easy access to the suite of sales tools that Daikin offer (registration required).
- An easy to use product specification library to quickly verify any spec item required, or to generate a submittal data sheet, guide spec or confirmation of the available accessories and options for a specific product (registration required).

Support and tools (continued)



Daikin eEquip application



Smartphone and mobile reference

- With the **Daikin eEquip application**, available for both iOS devices and Android devices, you can have the power of all Daikin product information and support material readily accessible on your mobile device or tablet.
- For rapid resolution to a system with an error code, or general troubleshooting needs, the **Dr. Daikin tool** is a helpful and quick reference tool that works via a standard desktop, tablet or smartphone and even SMS. When you need to understand or isolate the scope of one of Daikin's diagnostic codes, enter the code into the Dr. Daikin resource and automatically the tool will provide feedback of what the diagnostic code refers to and straightforward guidance on how to address the code. Visit www.drdaikin.com for further information.



www.DrDaikin.com

Daikin's tools and support enables consulting engineers, building owners and installers to optimize the life cycle cost of the VRV systems.



Daikin VRV Configurator



Daikin's online spare parts databank



After sales and service

With a strong commitment to sales tools to help design and apply the product is equally supported with a strong commitment on after-sales and service tools aimed at the service contractor or maintenance technician.

- **Daikin VRV Configurator** is a PC based software tool that allows an installing contractor to “set-up” the operating parameters and field settings of the VRV IV outdoor units off-site and then use a handy USB connection to upload those settings during the commissioning process. This helps save time and ensure that projects with multiple systems can be set up correctly and error free. The Configurator tool also allows for up to 48hrs of operation data from an installed system to be downloaded to a laptop computer for analysis if needed.
- **Daikin VRV Service Checker** is a PC based software tool that facilitates a connection to the system and monitors all components of the system including temperatures, pressures, compressor and fan speeds, and may other items and can be utilized to understand operational trends with the system and what is happening in the system at a specific time. This tool is very helpful when troubleshooting a system in the event of error or diagnostic notification.

- **Daikin's online spare parts databank** (registration required) is an easy to use graphically driven means of identifying what spare or replacement part might be needed during the life cycle of the VRV equipment. Using this resource will help you identify the part number, applicable model, any alternative part options, and the availability of the part both locally and globally.
- **Daikin University** offers Daikin's customers a variety of quality training programs designed to provide the tools and resources needed for our customers to be successful.
 - Our courses are designed by training professionals around specific objectives based on industry needs and job task analysis. We offer a choice of instructional settings based on the program goals and our students' needs including: online/on-demand web-based training, instructor led webinars, onsite training, and instructor-led classroom training at one of our many Daikin Authorized training facilities.



Daikin: The Premium Brand industry leader

DAIKIN Daikin Industries, Ltd. (DIL) is a global Fortune 1000 company which celebrated its 90th anniversary in May 2014. The company is recognized as the largest HVAC (Heating, Ventilating, Air Conditioning) manufacturer in the world. DIL is primarily engaged in developing indoor comfort products, systems and refrigeration products for residential, commercial and industrial applications. Its consistent success is derived, in part, from a focus on innovative, energy-efficient and premium quality indoor climate and comfort management solutions.



Before purchasing an appliance in this document, read important information about its estimated annual energy consumption, yearly operating cost, or energy efficiency rating that is available from your retailer.

WARNINGS:

- Always use a licensed installer or contractor to install this product. Do not try to install the product yourself. Improper installation can result in water or refrigerant leakage, electrical shock, fire or explosion.
- Use only those parts and accessories supplied or specified by Daikin. Ask a licensed contractor to install those parts and accessories. Use of unauthorized parts and accessories or improper installation of parts and accessories can result in water or refrigerant leakage, electrical shock, fire or explosion.
- Read the User's Manual carefully before using this product. The User's Manual provides important safety instructions and warnings. Be sure to follow these instructions and warnings.
- For any inquiries, contact your local Daikin sales office.



Daikin, and its design, VRV and REFNET are trademarks of Daikin Industries, Ltd.

